

Complete Unit:

Gas Rectangular Firepit - 900mm

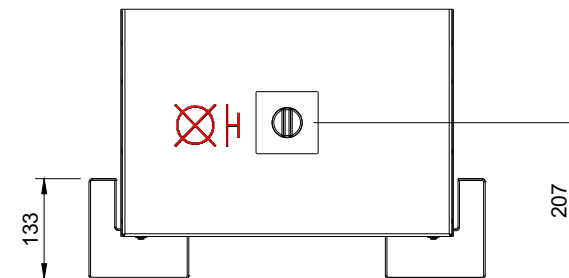

Gas Firepit Burner - 800mm

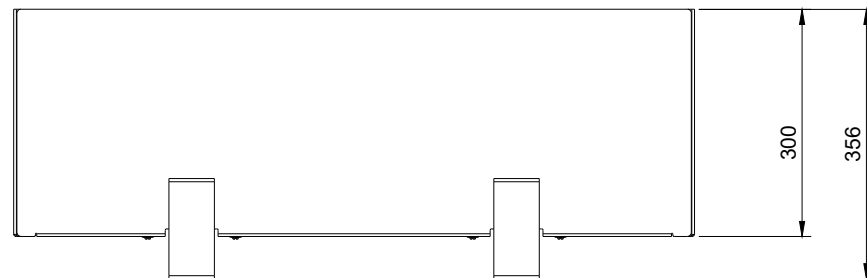

## 900mm Gas Rectangular Firepit

MOD-RCGFP-0-900-0-G-MS-0000-SF-CAA-Rectangular Firepit ASM

This drawing is copyright and remains the property of Signi Fires. It may not be retained, copied, or used without written consent.

Estimated Unit Weight	 Electrical supply by specialist unit for light fitting.	 Gas supply by specialist.		
38.2 kg	Projection 	Scale 1:10	Sheet A4	Creation Date 2025/10/22

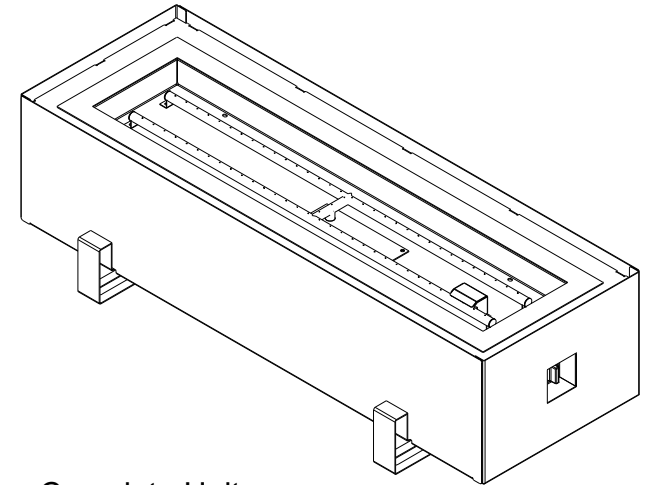
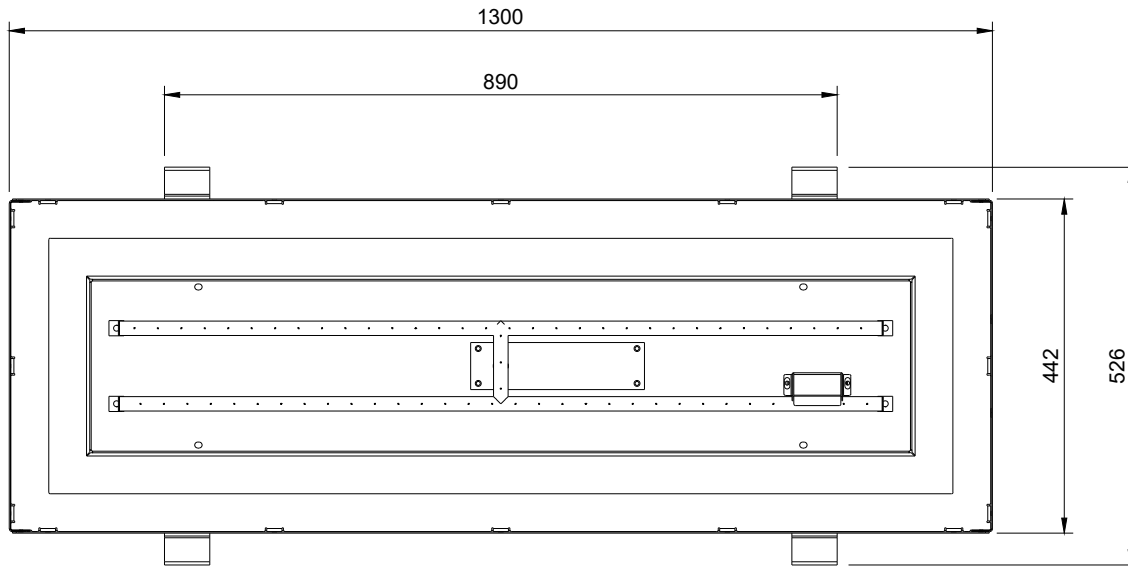

Complete Unit:

Gas Rectangular Firepit - 1300mm

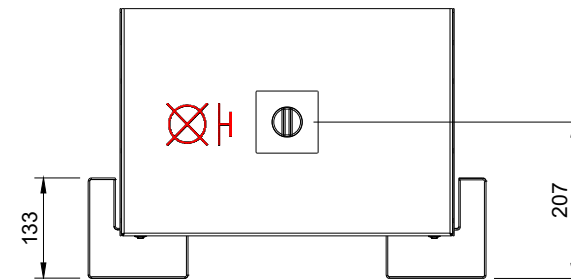
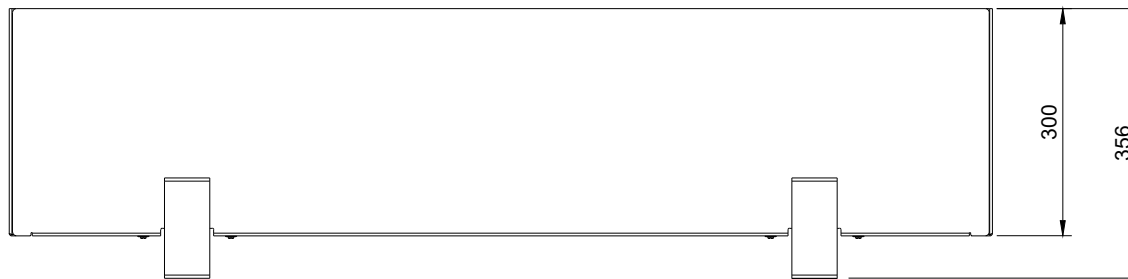

Gas Firepit Burner - 1200mm



### 1300mm Gas Rectangular Firepit

MOD-RCGFP-0-1300-0-G-MS-0000-SF-CAA-Rectangular Firepit ASM

This drawing is copyright and remains the property of Signi Fires. It may not be retained, copied, or used without written consent.

Estimated Unit Weight	 Electrical supply by specialist unit for light fitting.	 Gas supply by specialist.		
48.0 kg	Projection 	Scale 1:10	Sheet A4	Creation Date 2025/10/22

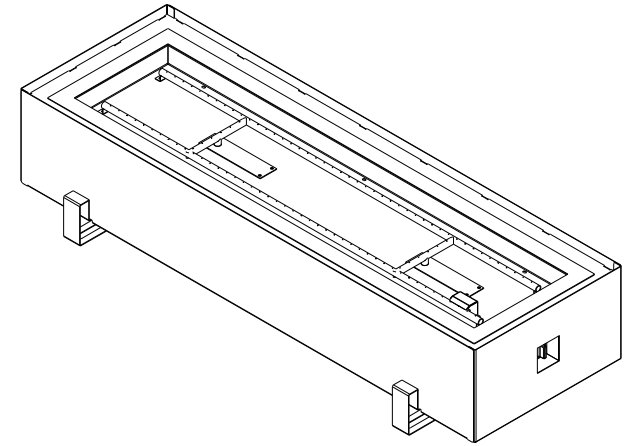
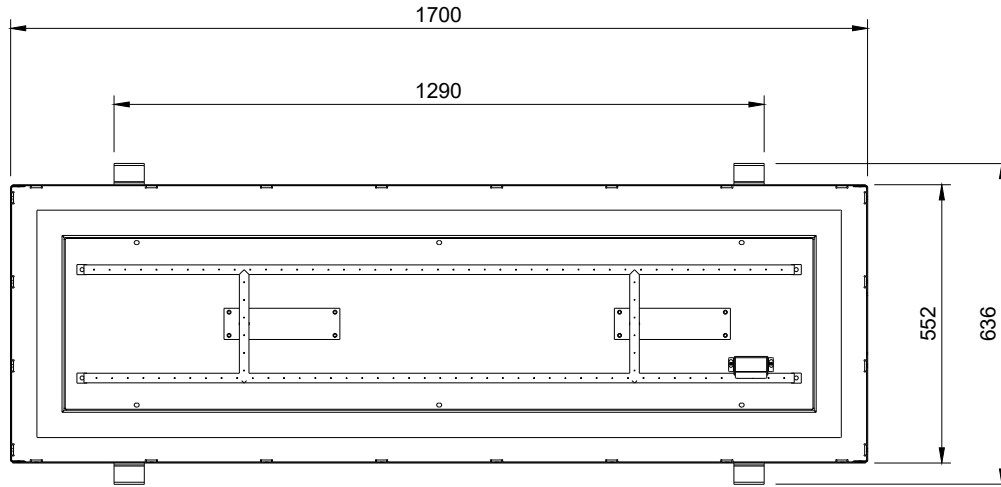

Complete Unit:

Gas Rectangular Firepit - 1700mm

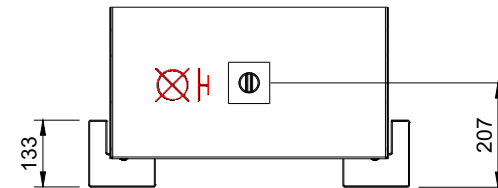
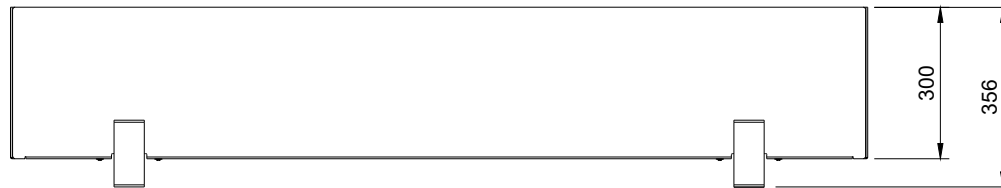

Gas Firepit Burner - 1600mm



### 1700mm Gas Rectangular Firepit

MOD-RCGFP-0-1700-0-G-MS-0000-SF-CAA-Rectangular Firepit ASM

This drawing is copyright and remains the property of Signi Fires. It may not be retained, copied, or used without written consent.

Estimated Unit Weight	 Electrical supply by specialist unit for light fitting.	 Gas supply by specialist.		
70.1 kg	Projection 	Scale 1:15	Sheet A4	Creation Date 2025/10/22

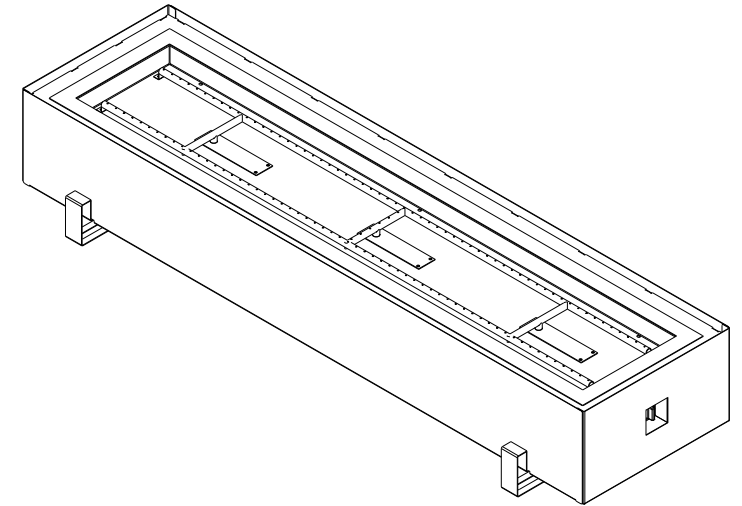
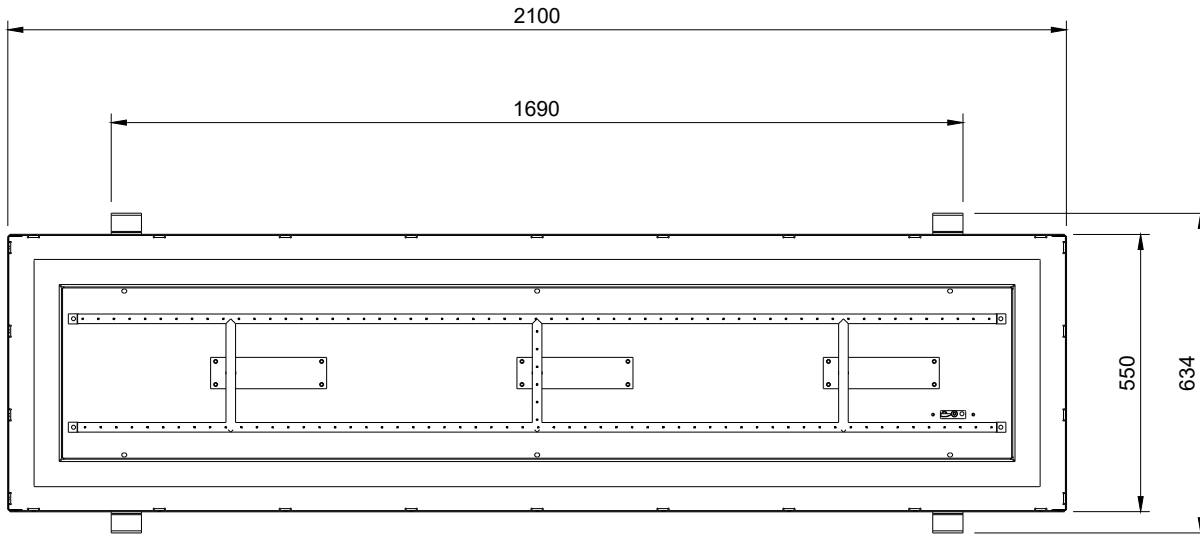

Complete Unit:

Gas Rectangular Firepit - 2100mm

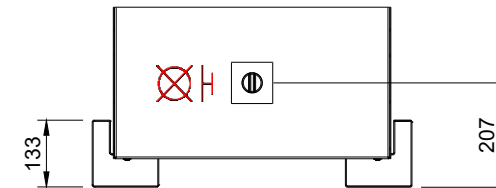
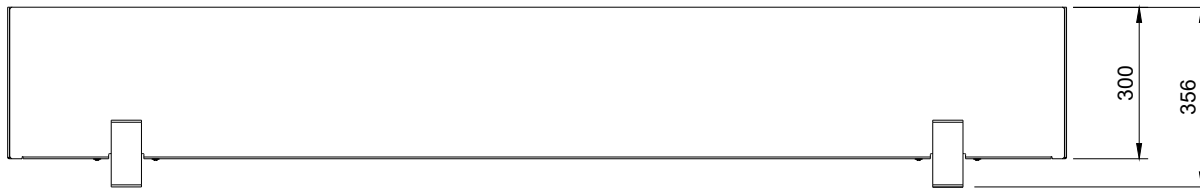

Gas Firepit Burner - 2000mm



### 2100mm Gas Rectangular Firepit

MOD-RCGFP-0-2100-0-G-MS-0000-SF-CAA-Rectangular Firepit ASM

This drawing is copyright and remains the property of Signi Fires. It may not be retained, copied, or used without written consent.

Estimated Unit Weight	 Electrical supply by specialist unit for light fitting.	 Gas supply by specialist.
98.1 kg	Projection 	Scale 1:15
	Sheet A4	Creation Date 2025/10/22

Unit Sizes	A	B	C
800mm	811	351	65
1200mm	1209	351	65
1600mm	1609	464	65
2000mm	2009	464	65

\*Dimensions given are to the outside of the lid (mm).

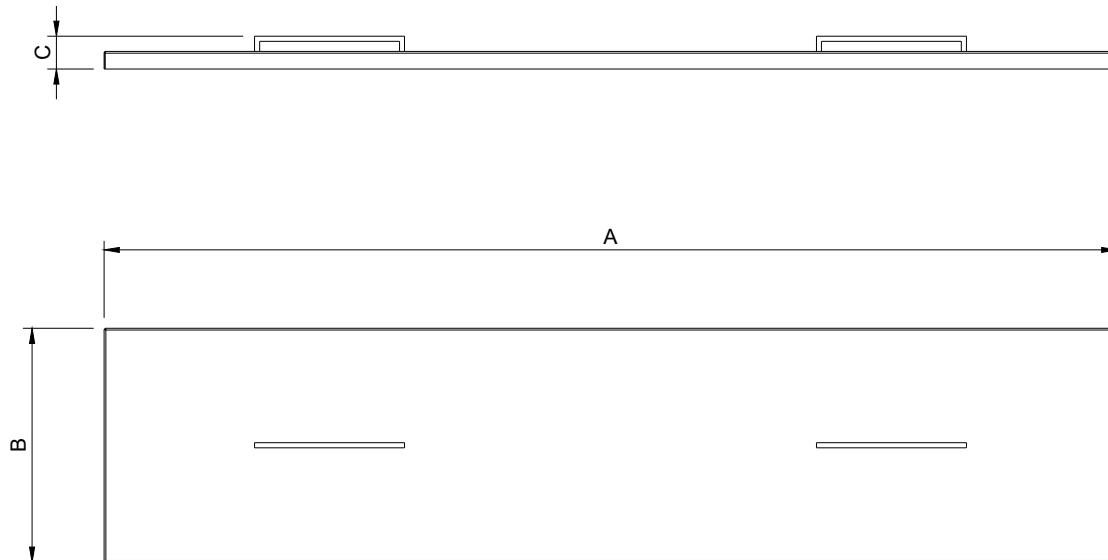

## Rectangular Firepit Burner Lids

RCGFP-MS-0-2100-0-G-CA

This drawing is copyright and remains the property of Signi Fires. It may not be retained, copied, or used without written consent.

Est. Unit Weight	Projection	Scale	Sheet	Creation Date
63.5 kg		1:15	A4	2025/09/30