

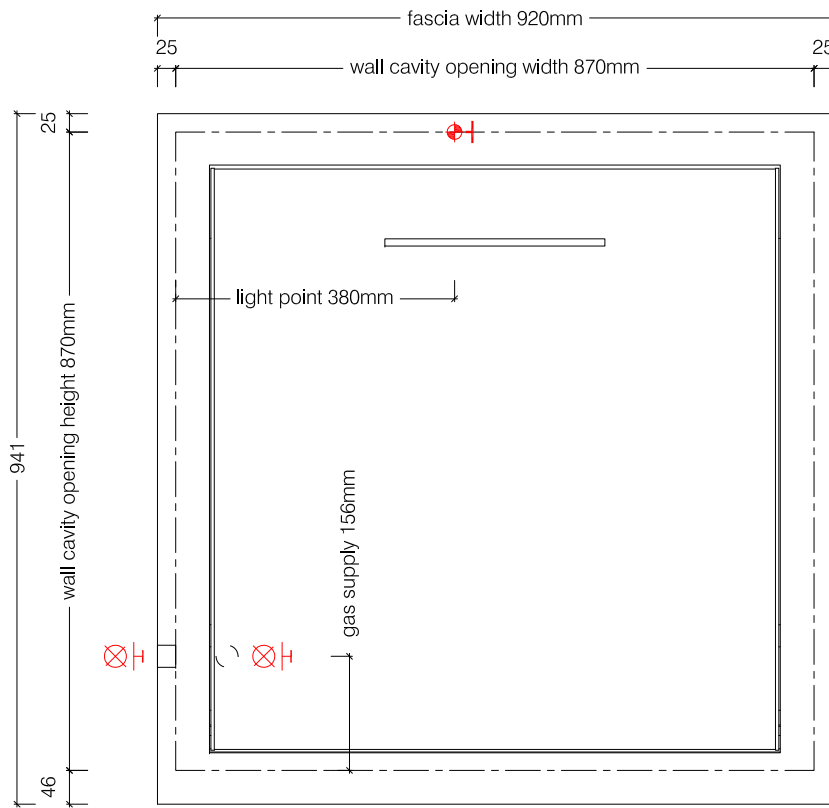

Top View



Front View

-  Electrical supply by specialist to top of unit for light fitting
-  Gas supply by specialist for gas griller insert

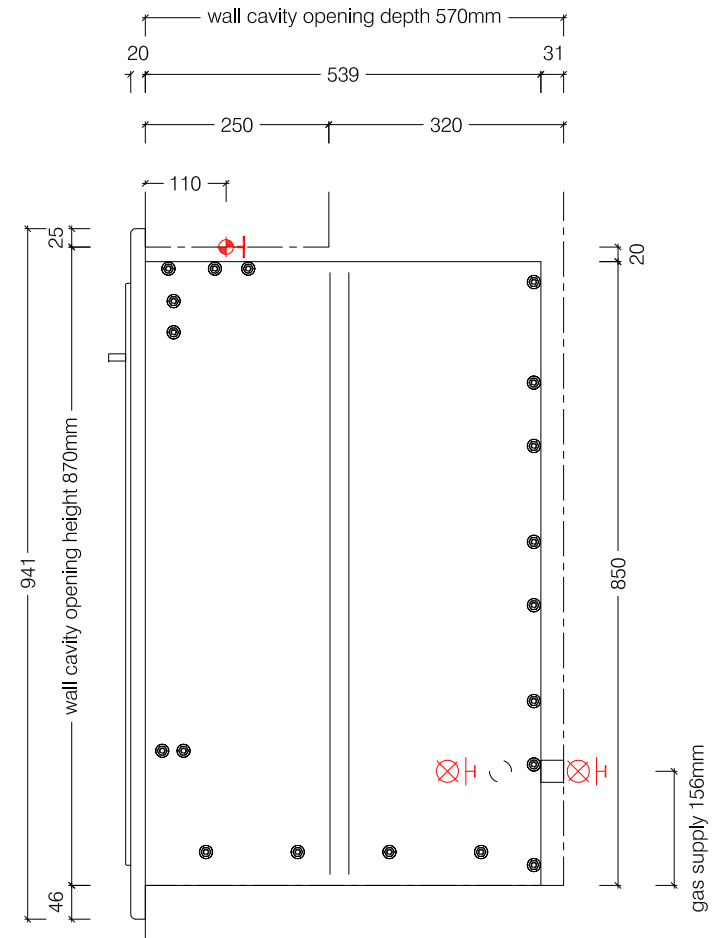



Side View

Minimum Chimney
Internal size
350 * 450 mm

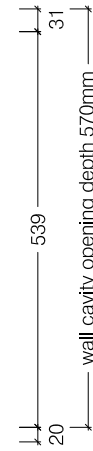
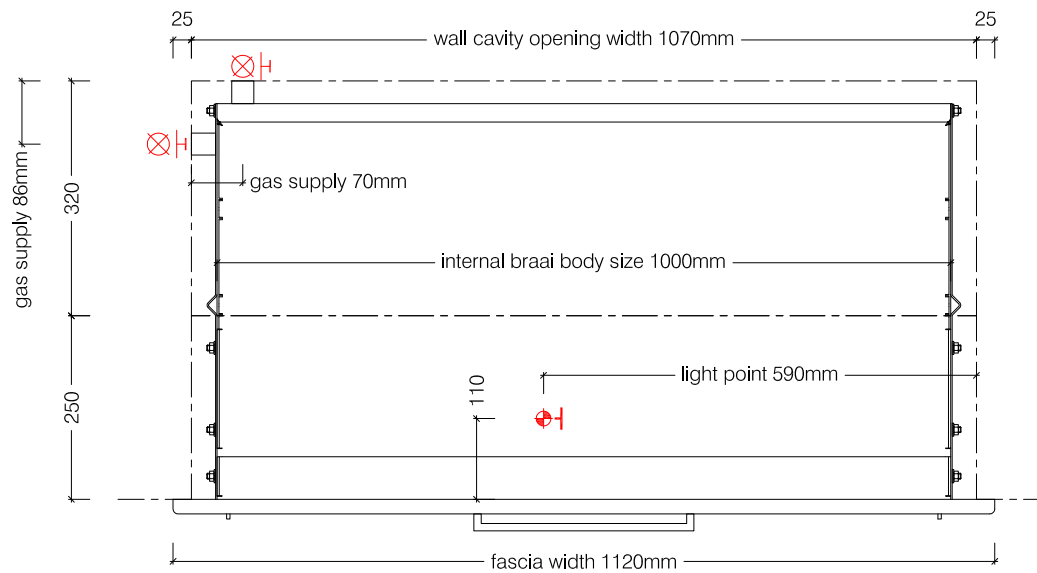
800 Built In Braai Body



-  Electrical supply by specialist to top of unit for light fitting
-  Gas supply by specialist for gas griller insert

Top View

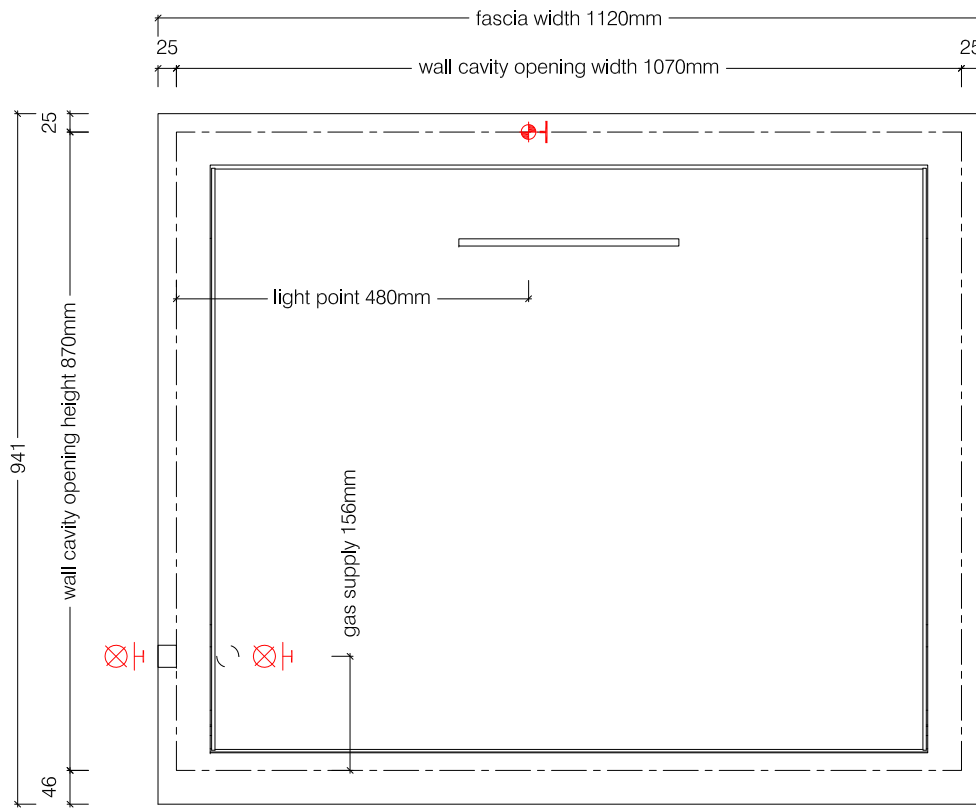

Front View

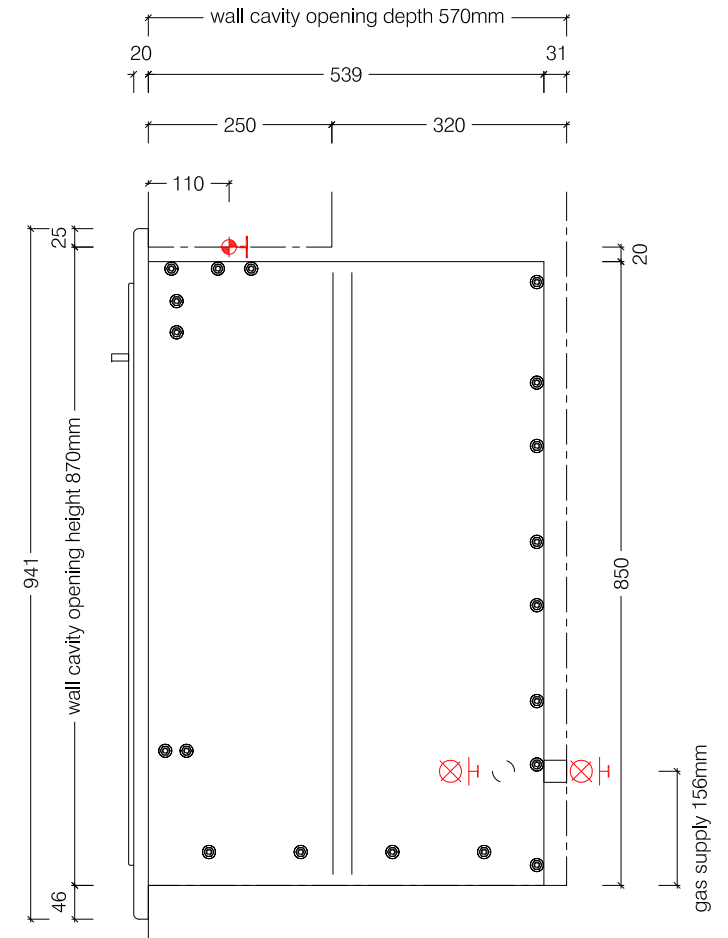

Side View

Minimum Chimney
Internal size
350 * 450 mm

1000 Built In Braai Body

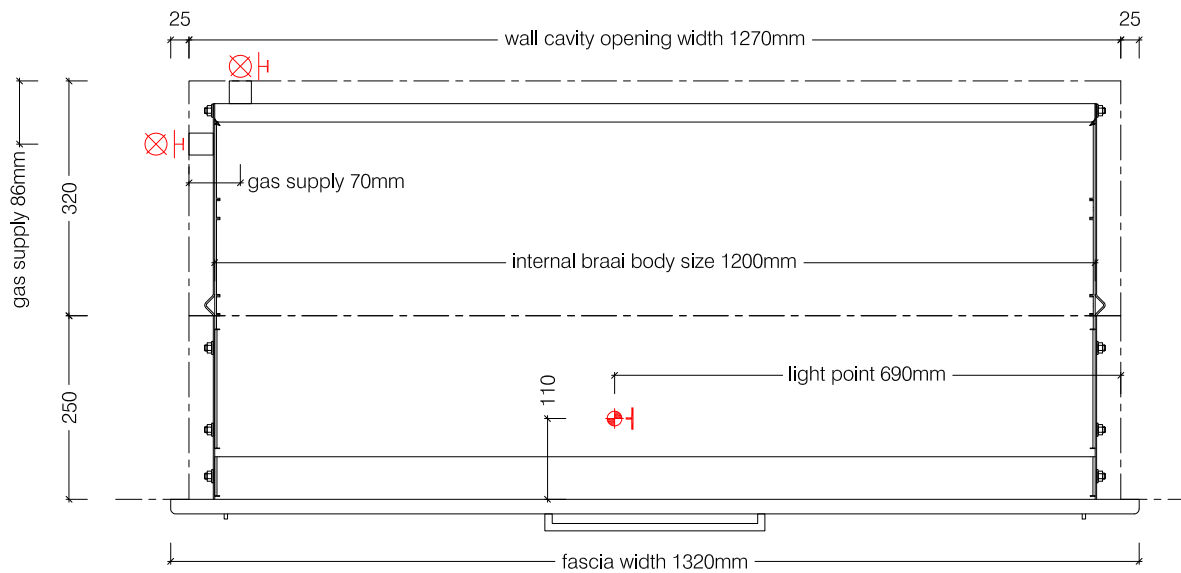

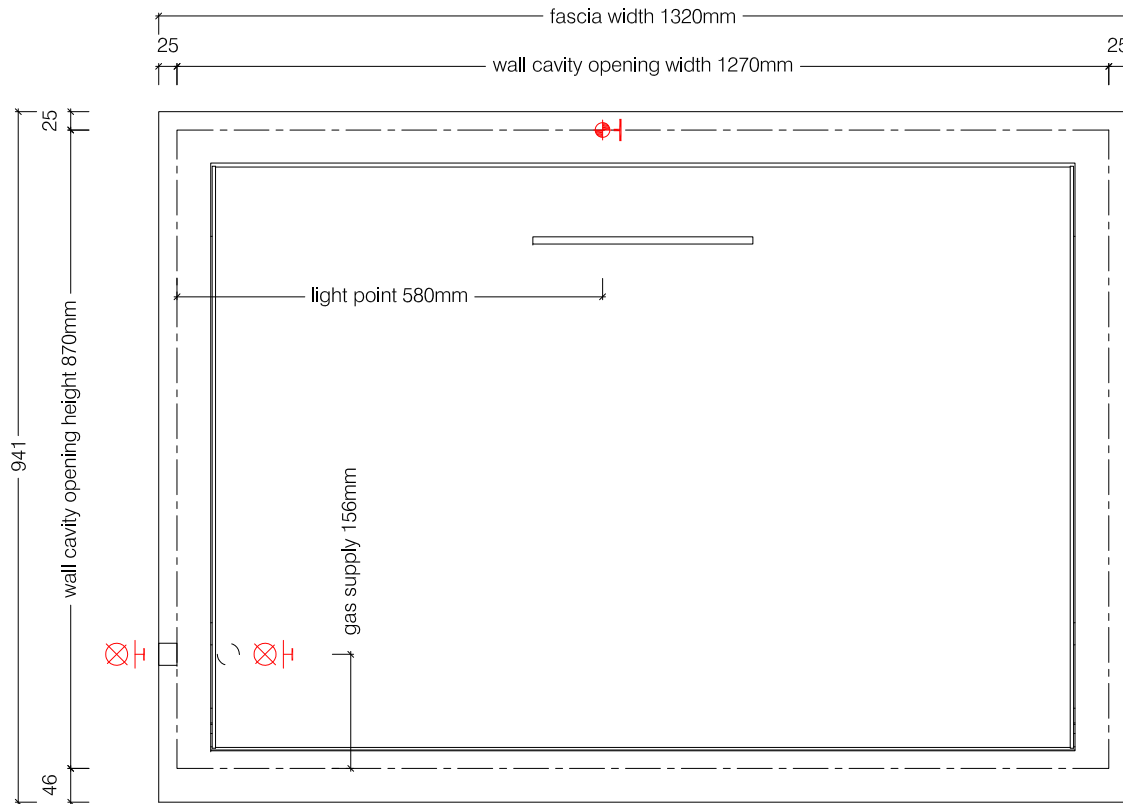

Top View



Front View



-  Electrical supply by specialist to top of unit for light fitting
-  Gas supply by specialist for gas grill insert

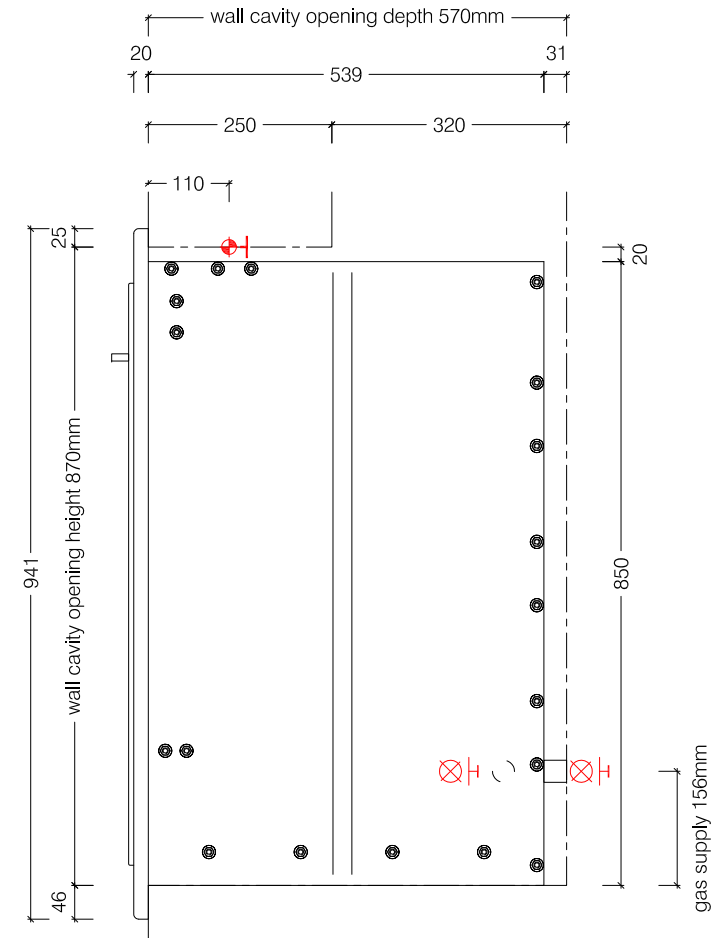

Side View

Minimum Chimney
Internal size
350 * 450 mm

1200 Built In Braai Body

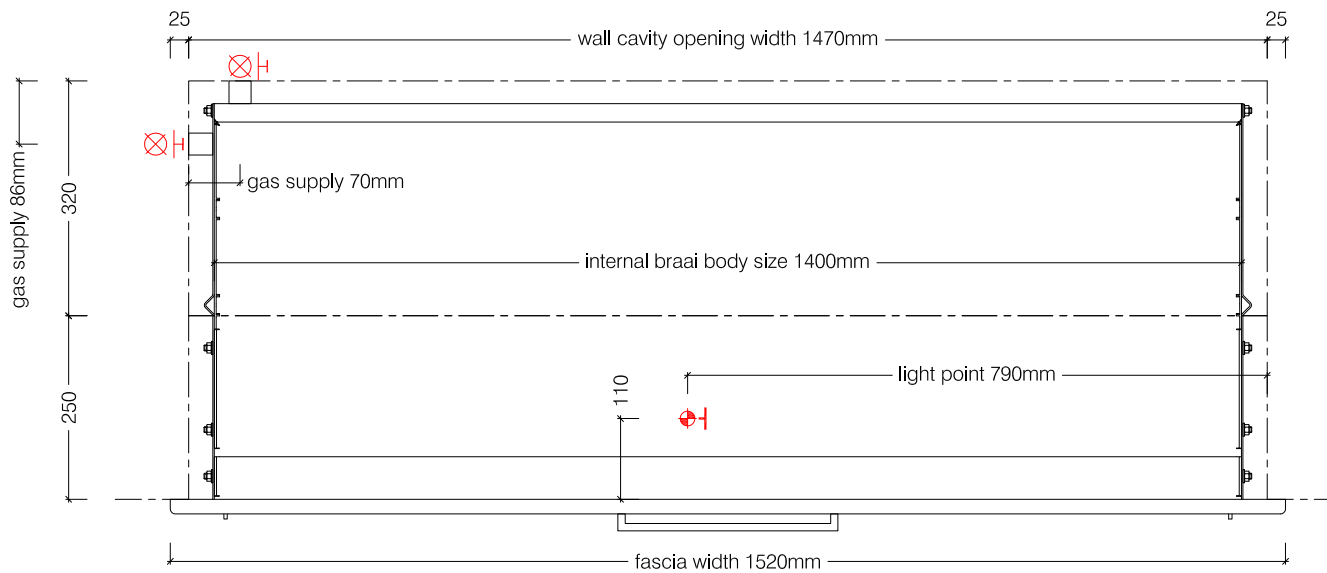

Top View

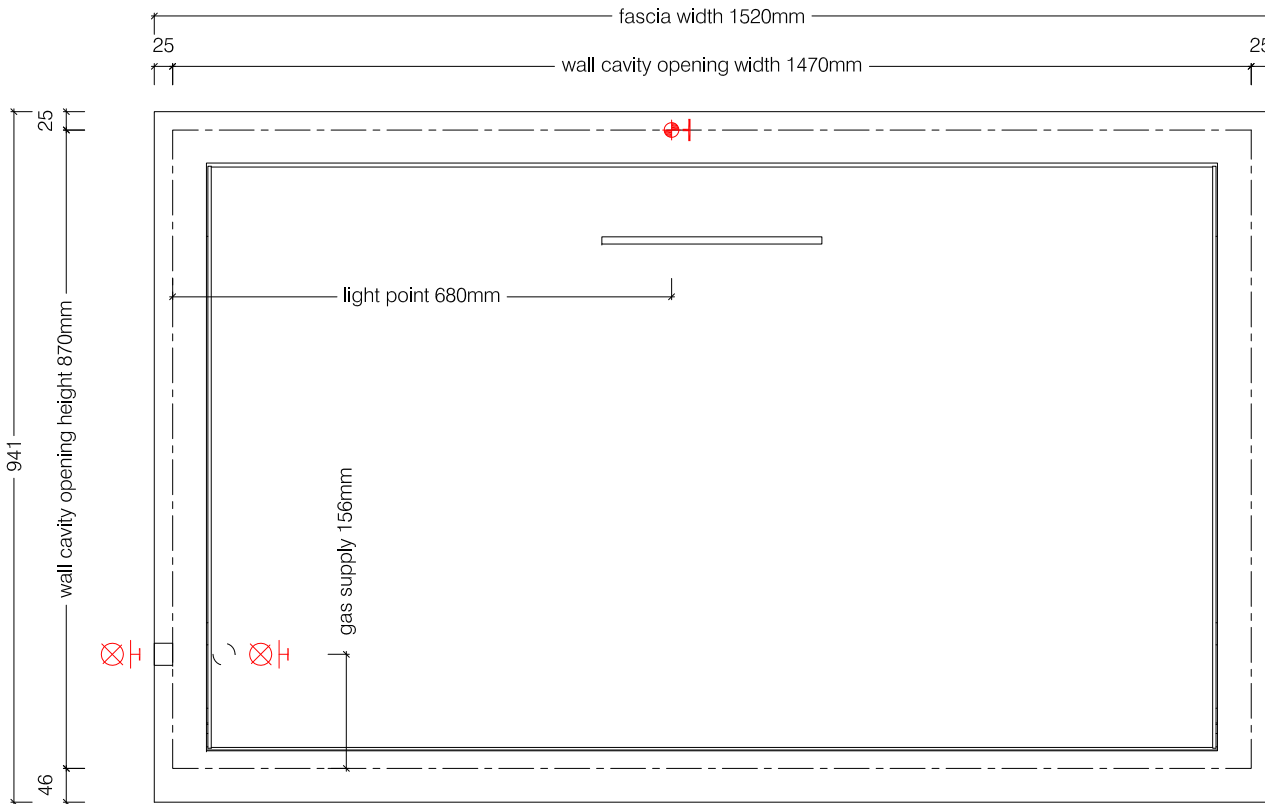



Front View

1400 Built In Braai Body

© This drawing is copyright and remains the property of Signi Fires. It may not be retained, copied or used without written consent.



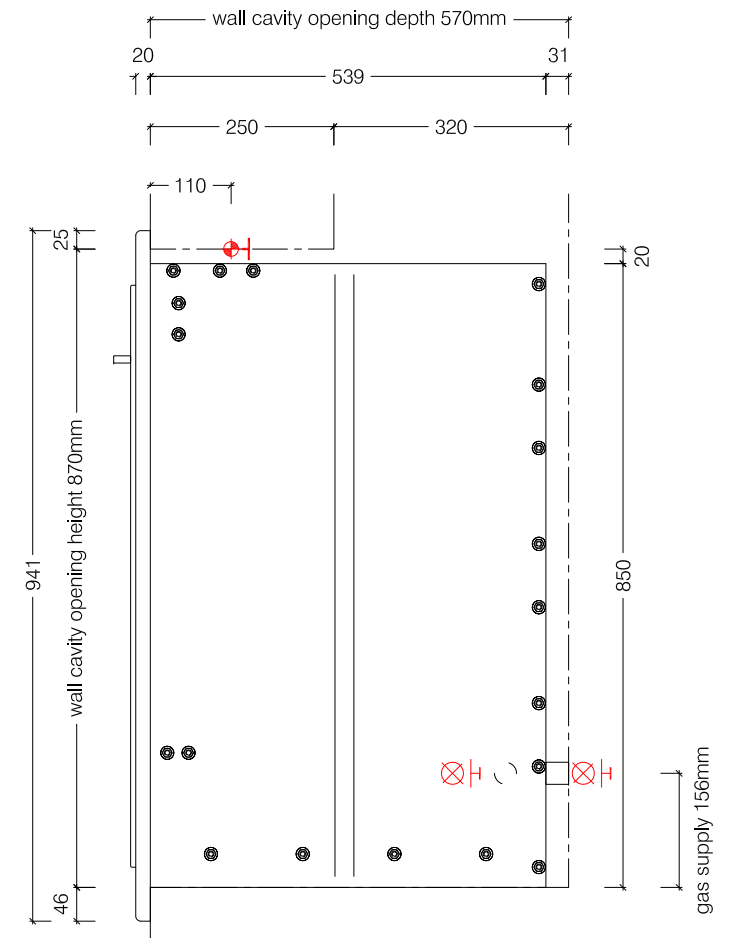

 Electrical supply by specialist to top of unit for light fitting

 Gas supply by specialist for gas grill insert



Side View

Minimum Chimney
Internal size
350 * 450 mm

-  Electrical supply by specialist to top of unit for light fitting
-  Gas supply by specialist for gas griller insert

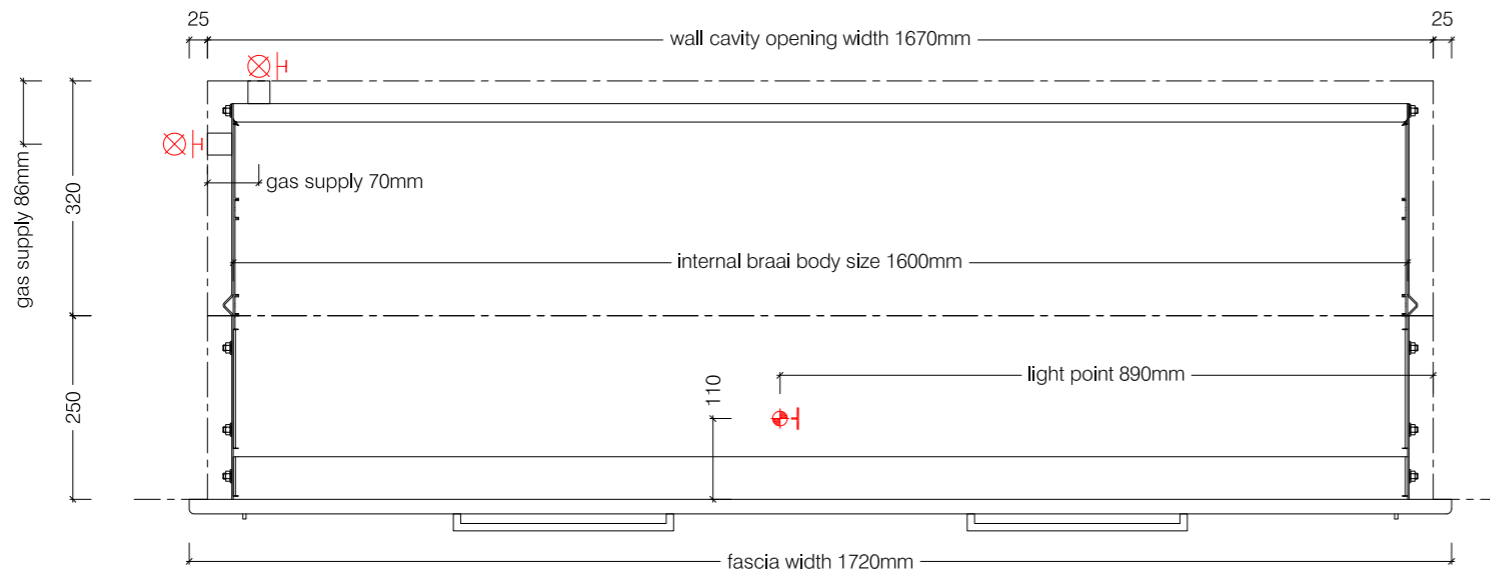

Top View

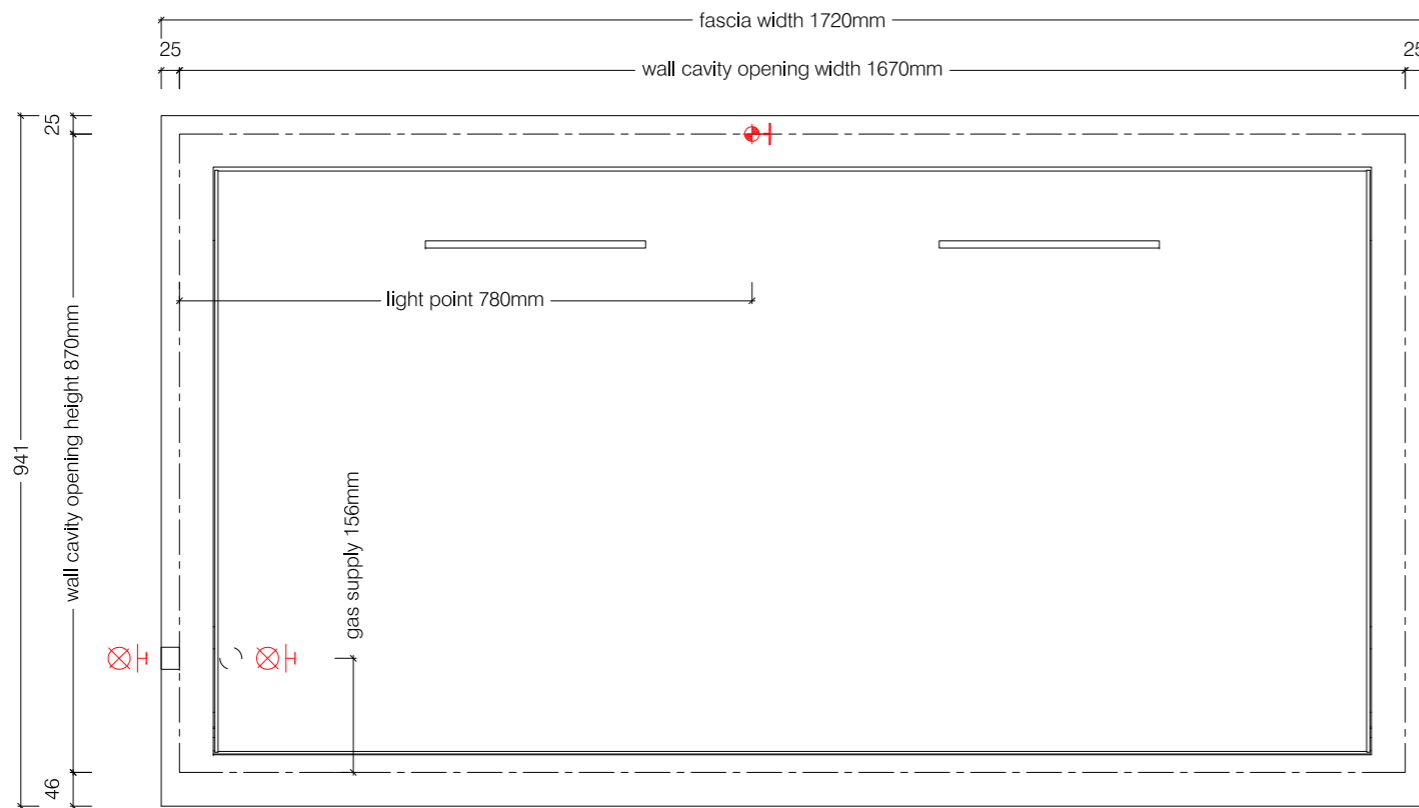

Front View

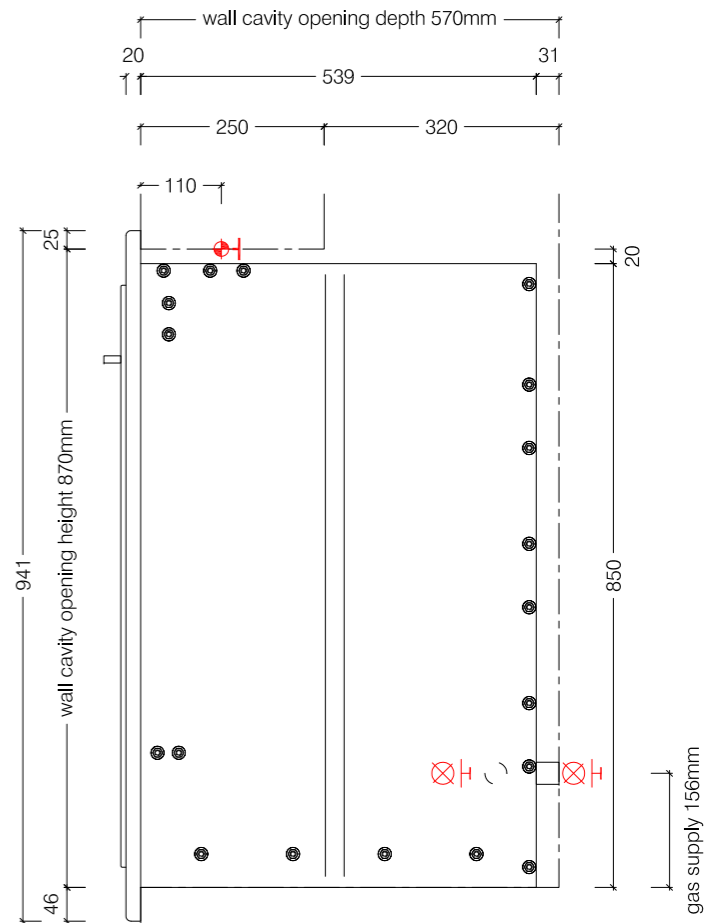



Side View

Minimum Chimney
Internal size
350 * 550 mm

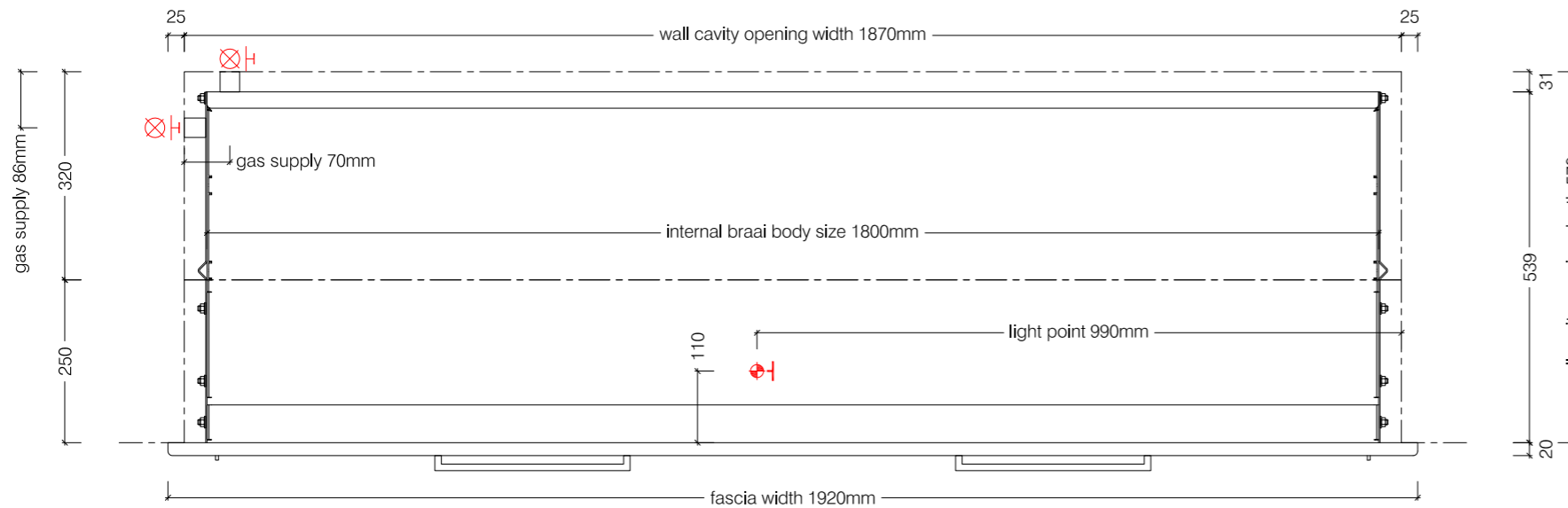
1600 Built In Braai Body



-  Electrical supply by specialist to top of unit for light fitting
-  Gas supply by specialist for gas grill insert

Top View

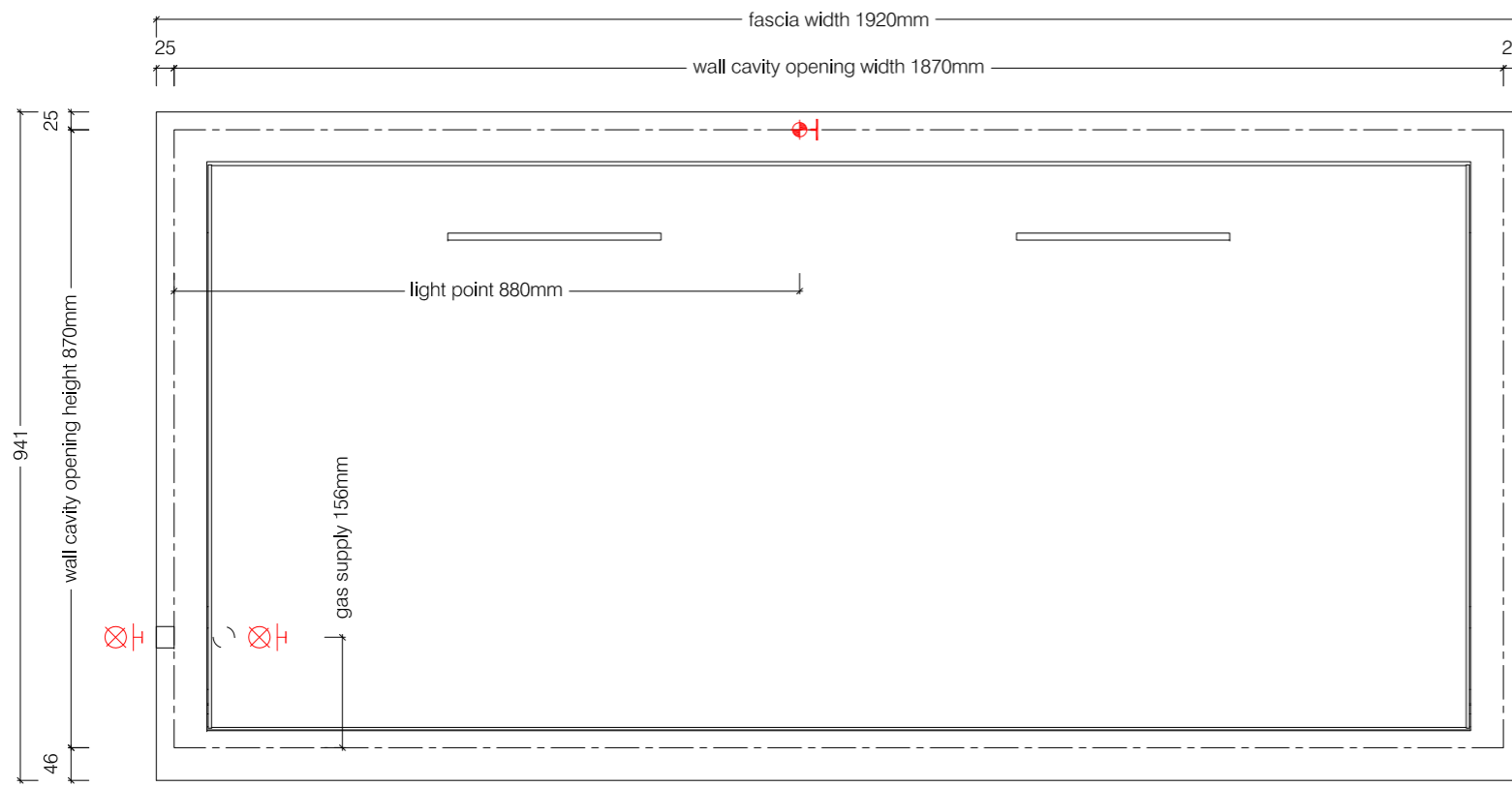

Front View

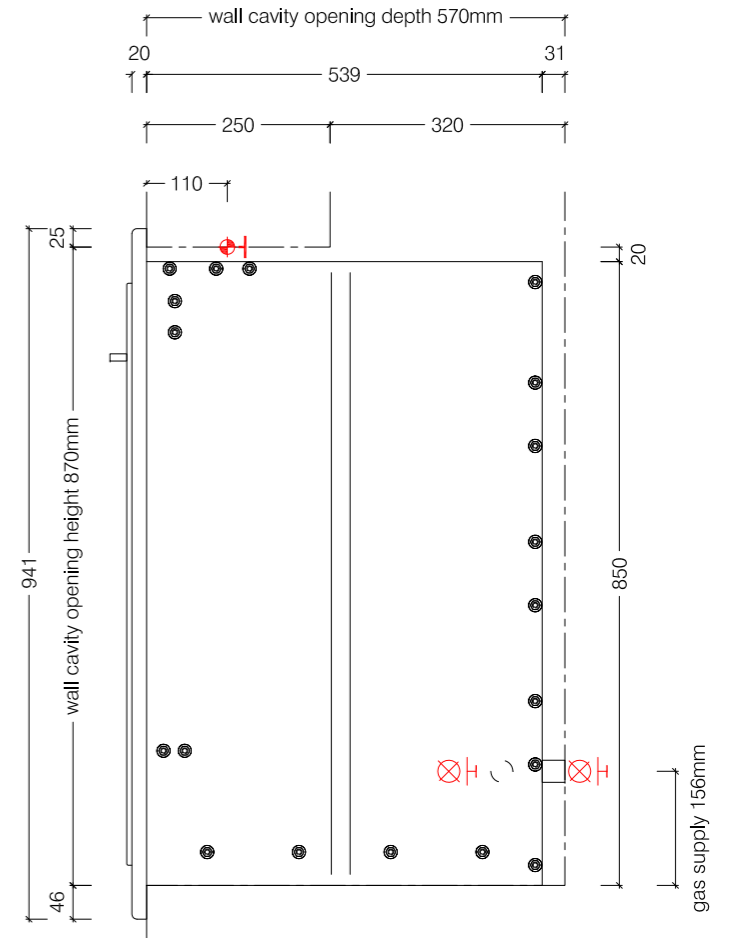

Side View

Minimum Chimney
Internal size
350 * 450 mm

1800 Built In Braai Body

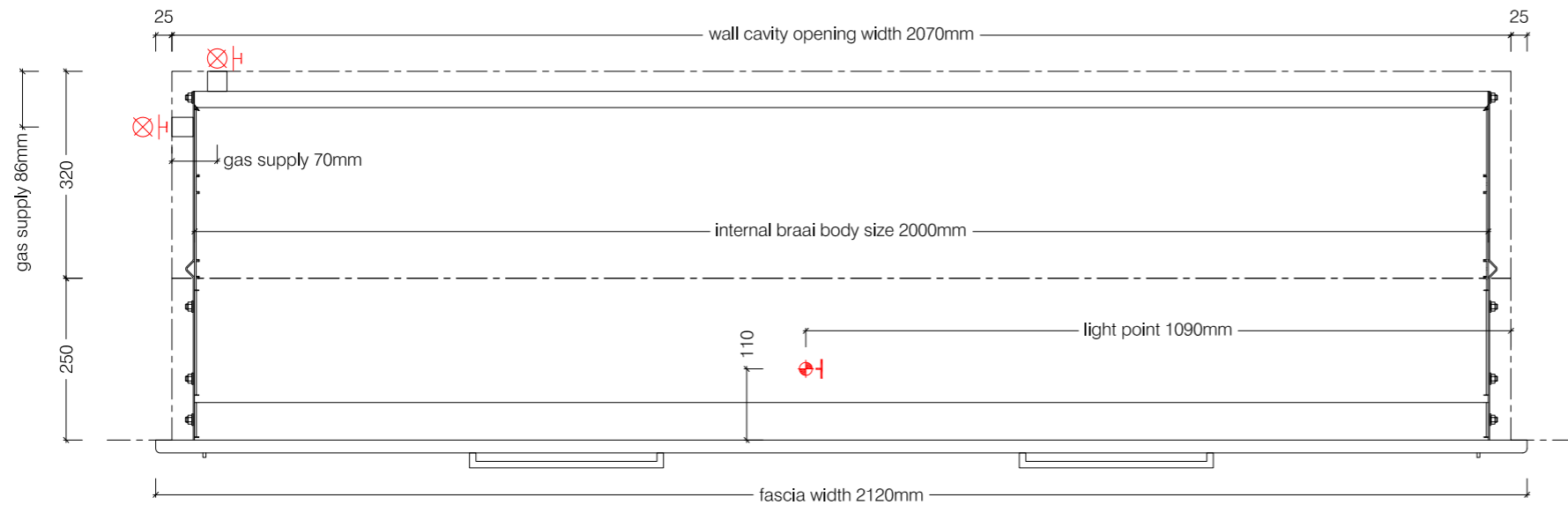

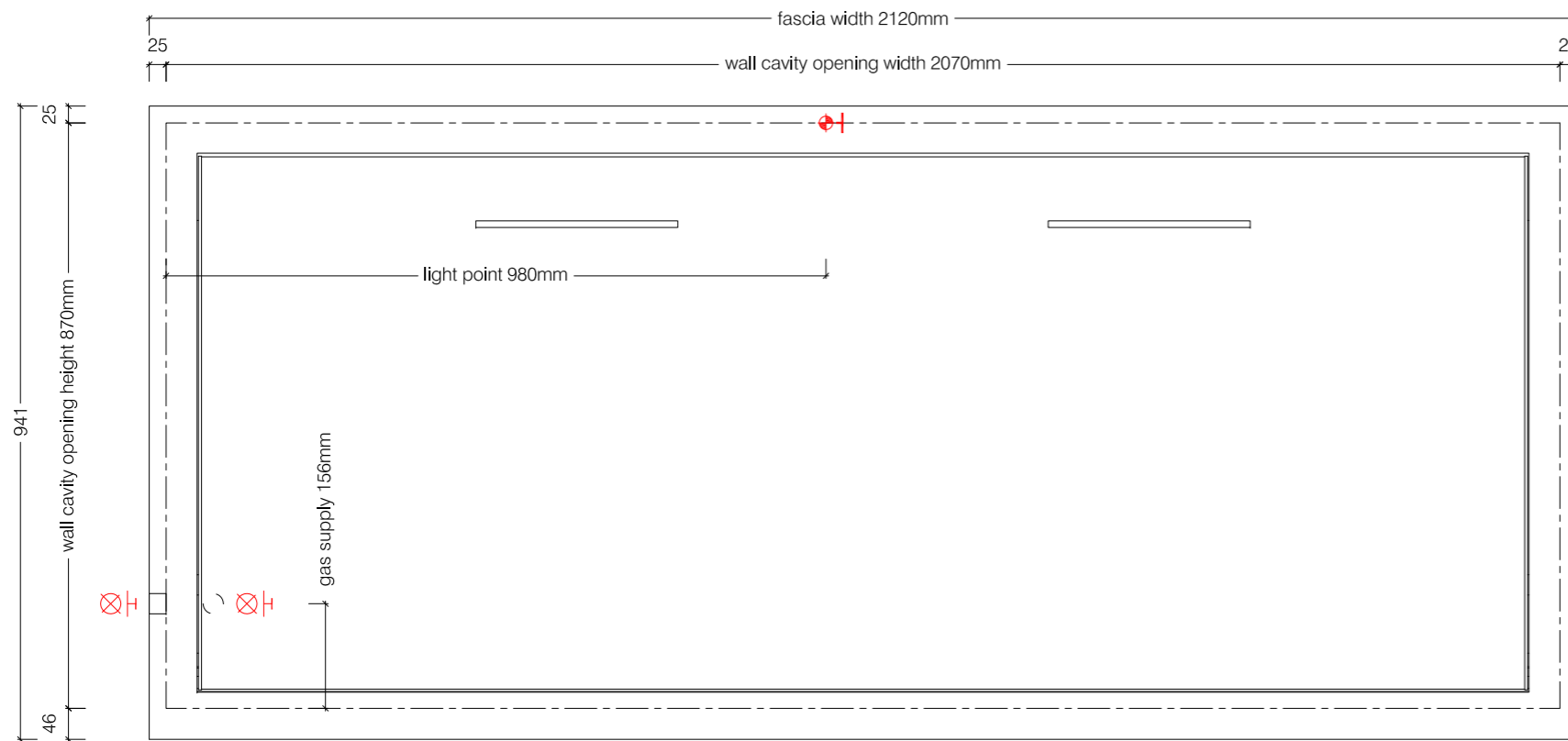

Top View

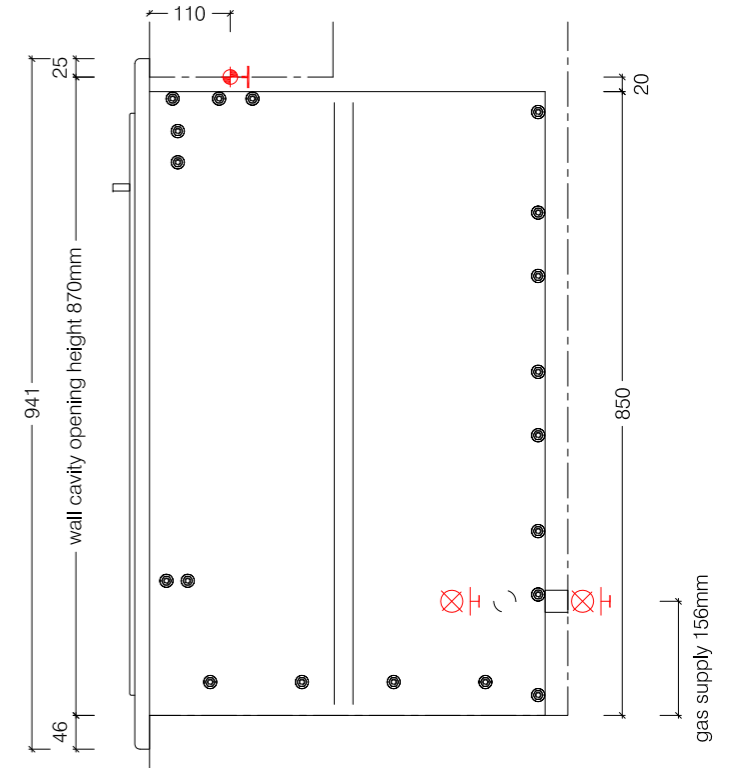
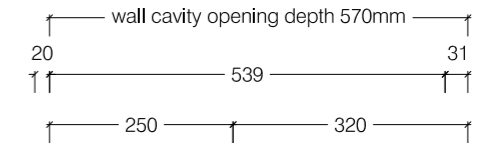

Front View



Side View

-  Electrical supply by specialist to top of unit for light fitting
-  Gas supply by specialist for gas griller insert

Minimum Chimney
Internal size
350 * 650 mm

2000 Built In Braai Body

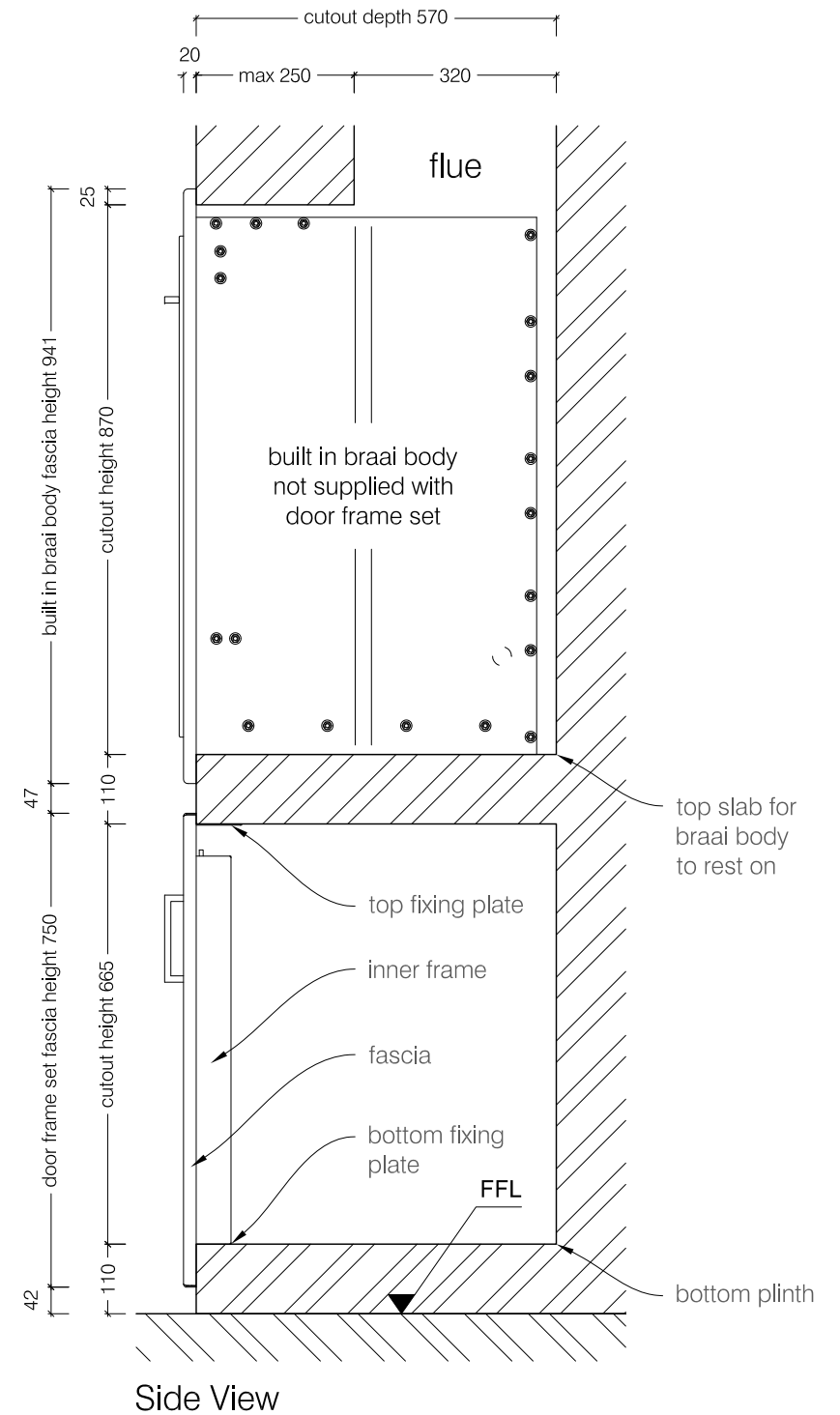
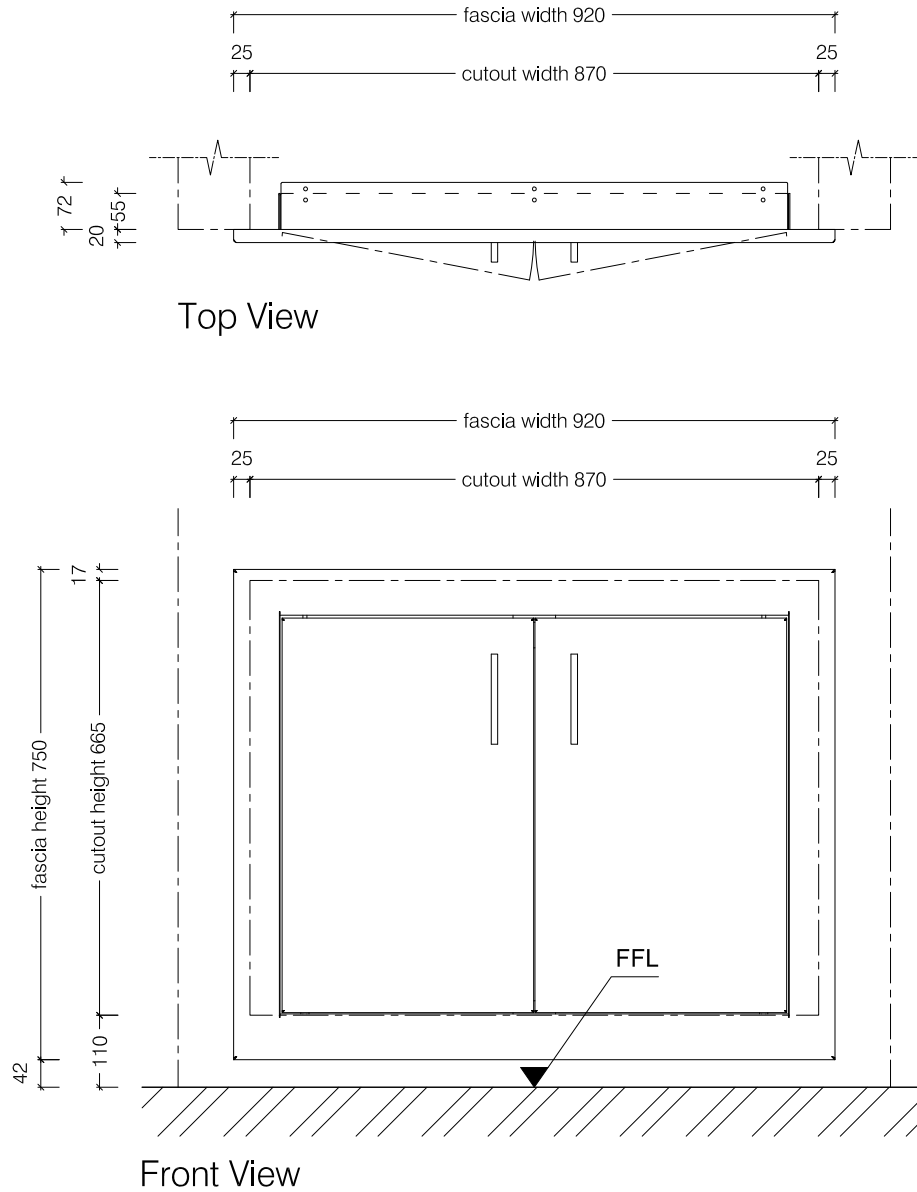

800 Door Frame Set

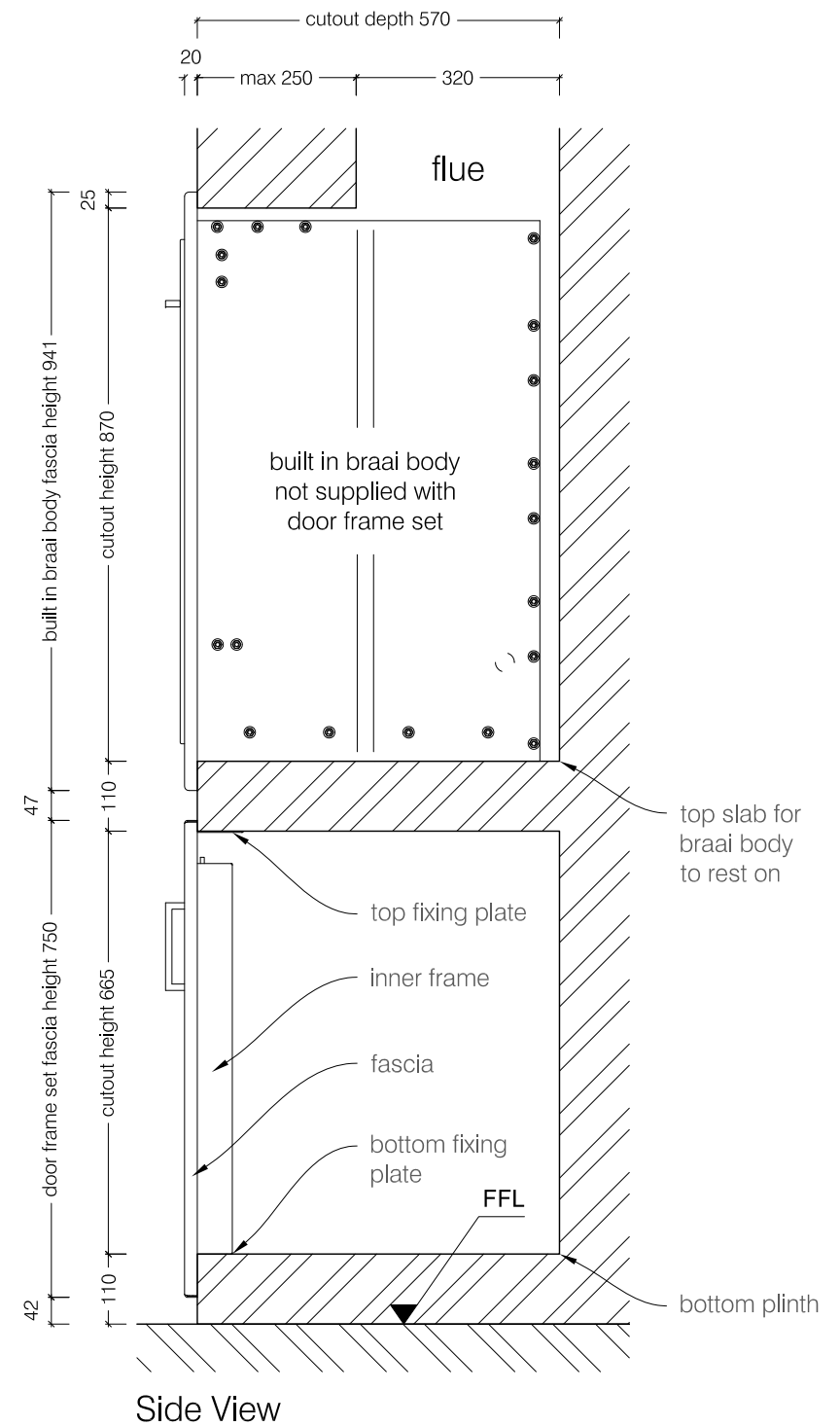
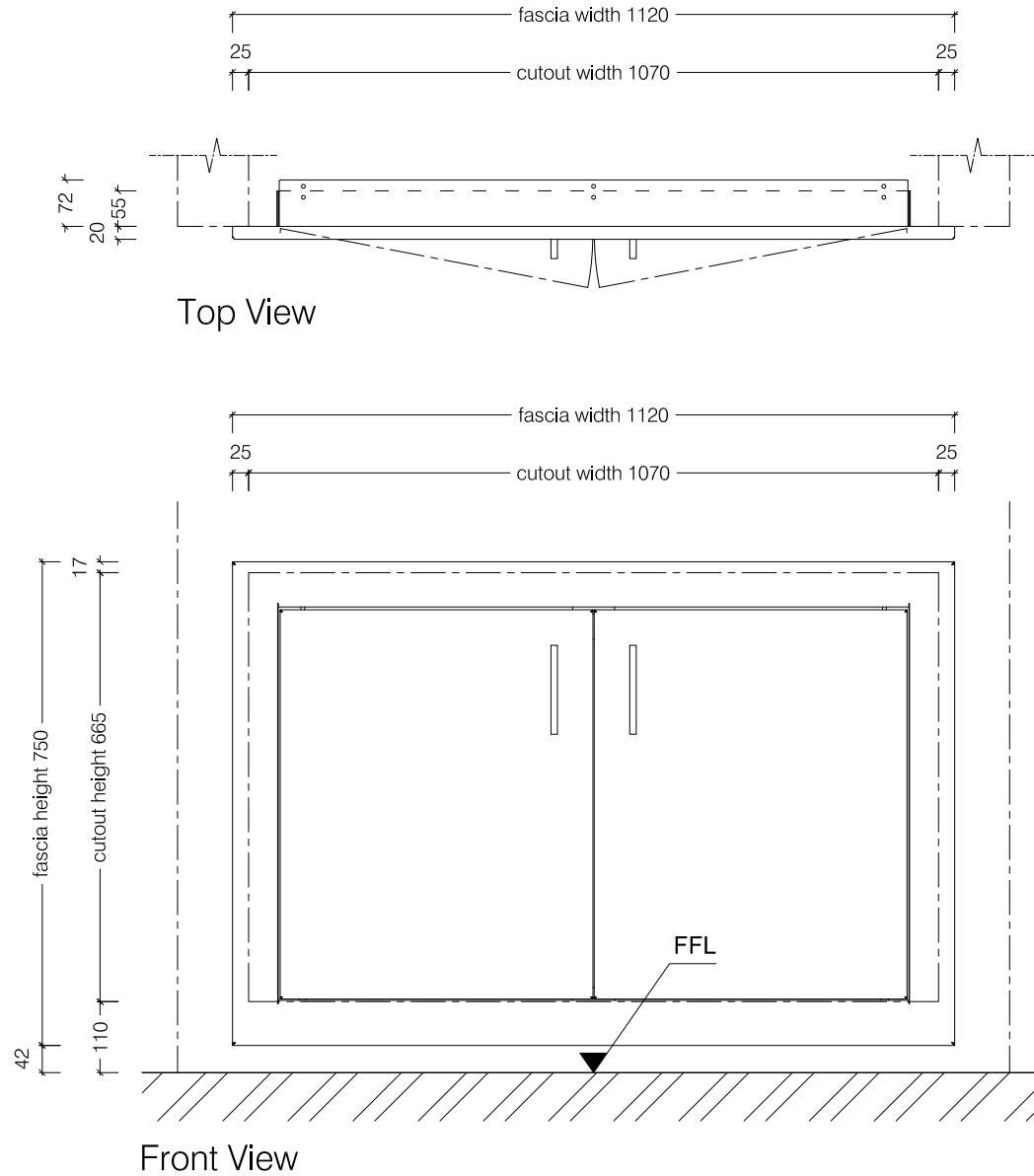

1000 Door Frame Set

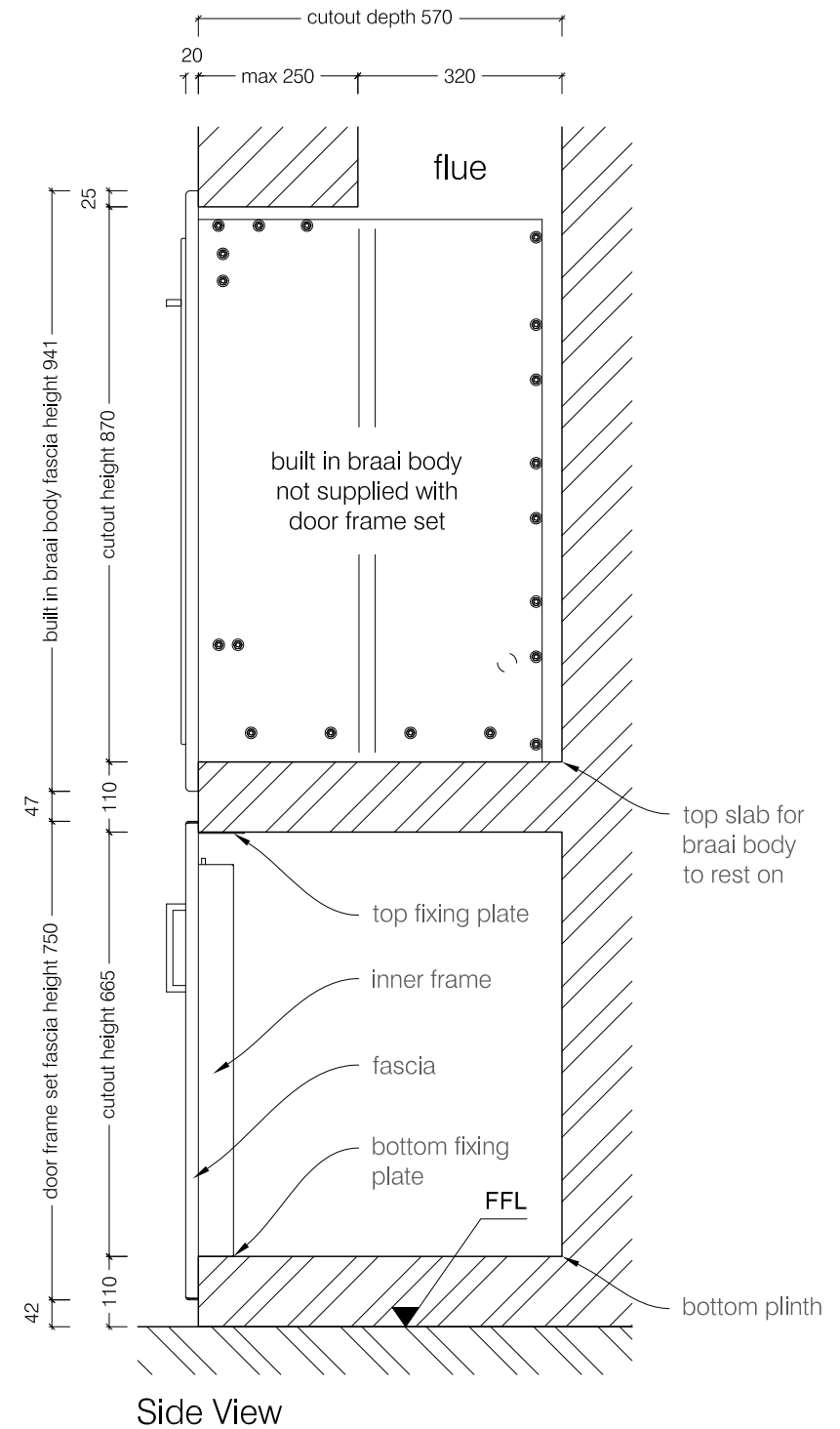
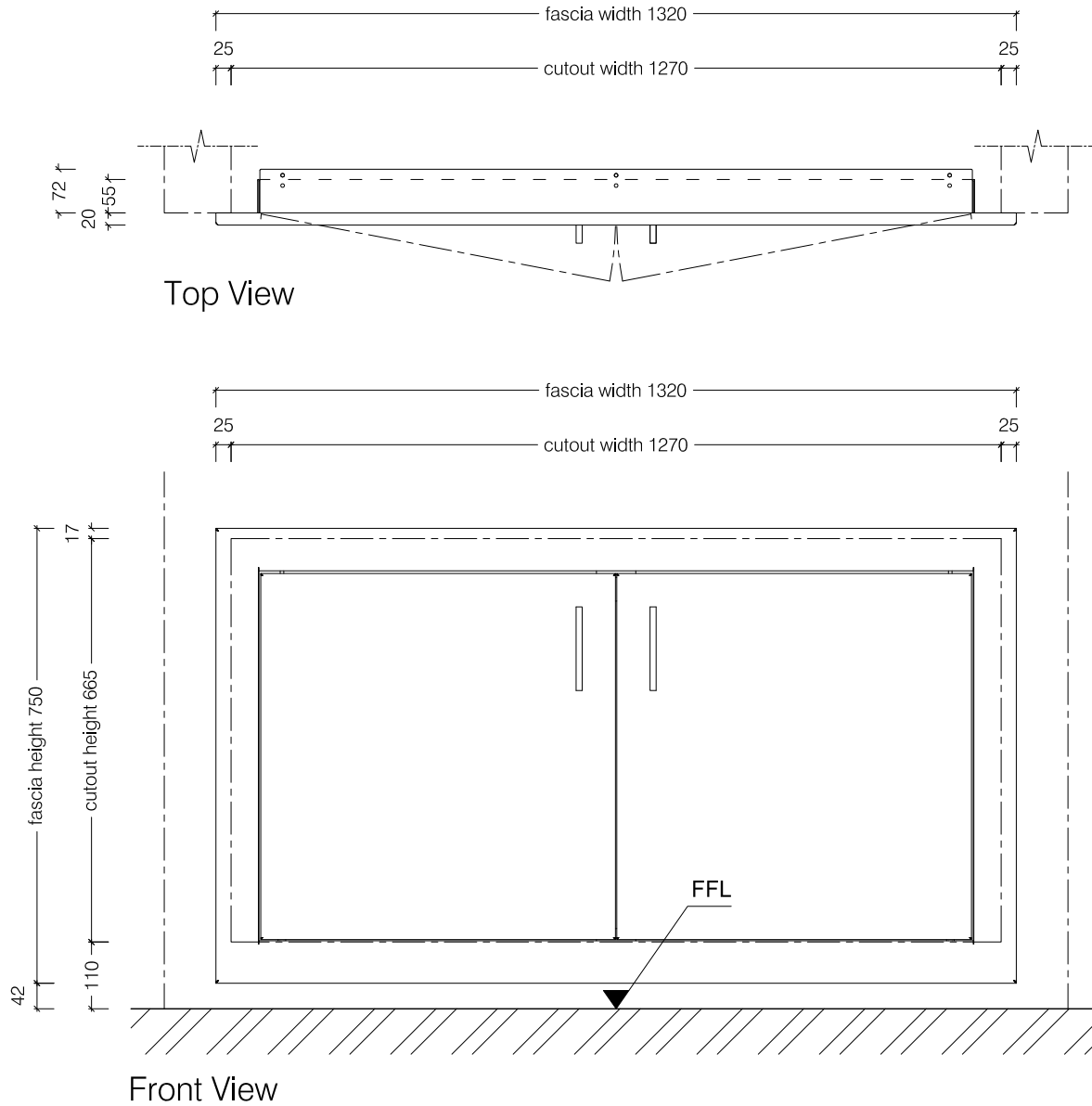

1200 Door Frame Set

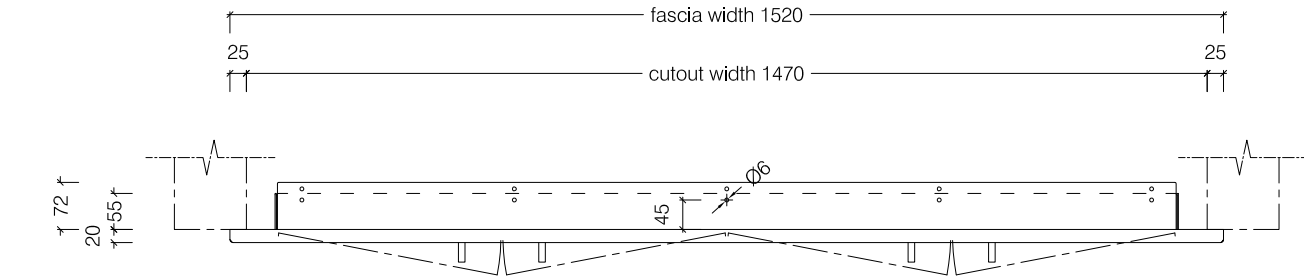

Top View

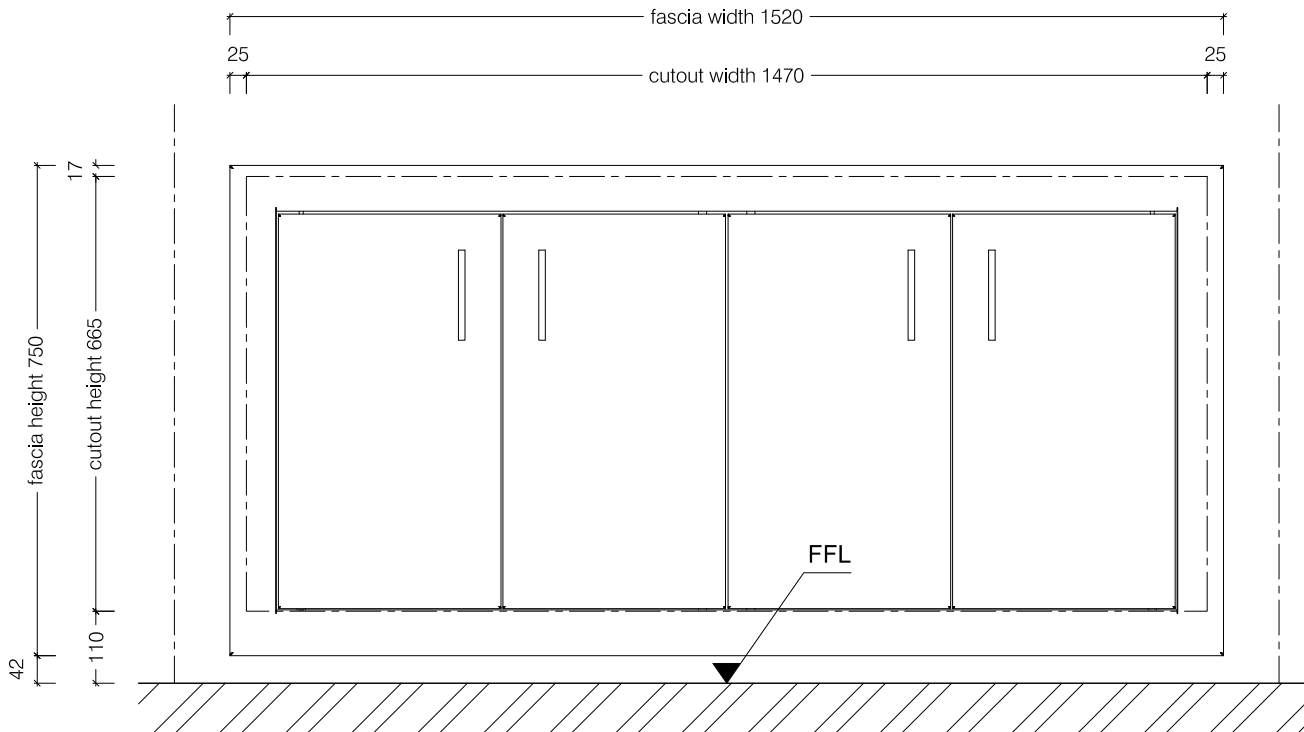

Front View

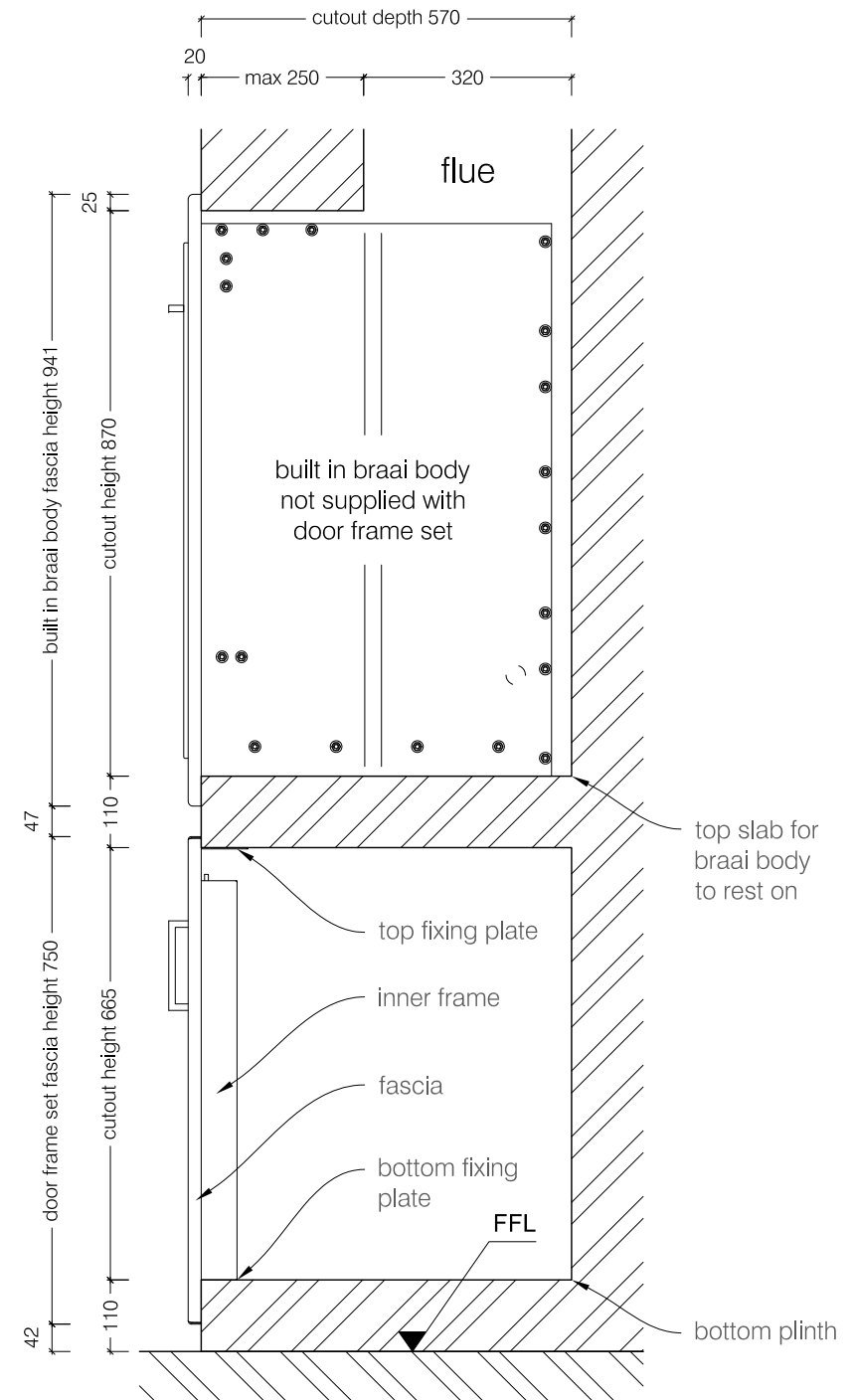

Side View

1400 Door Frame Set

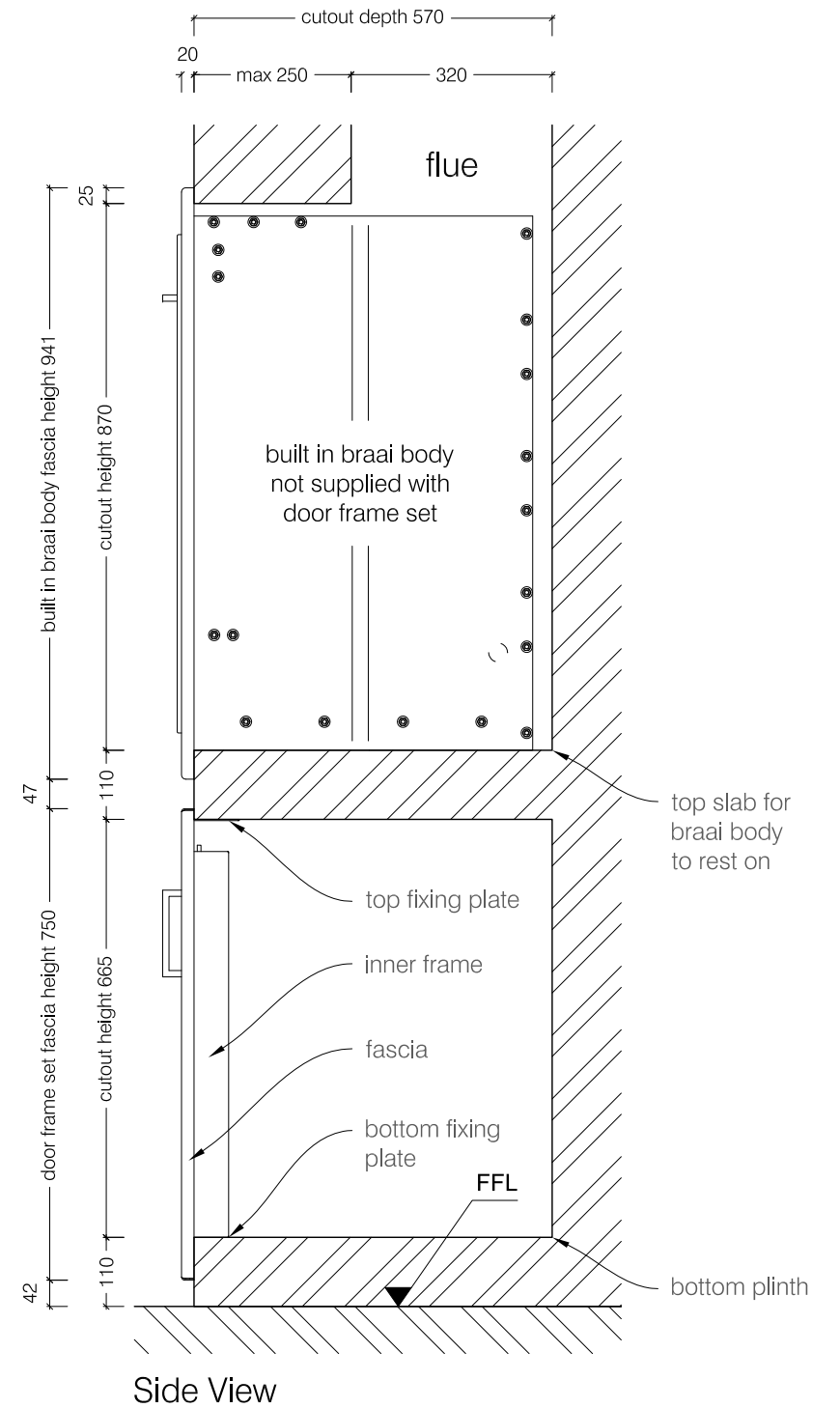
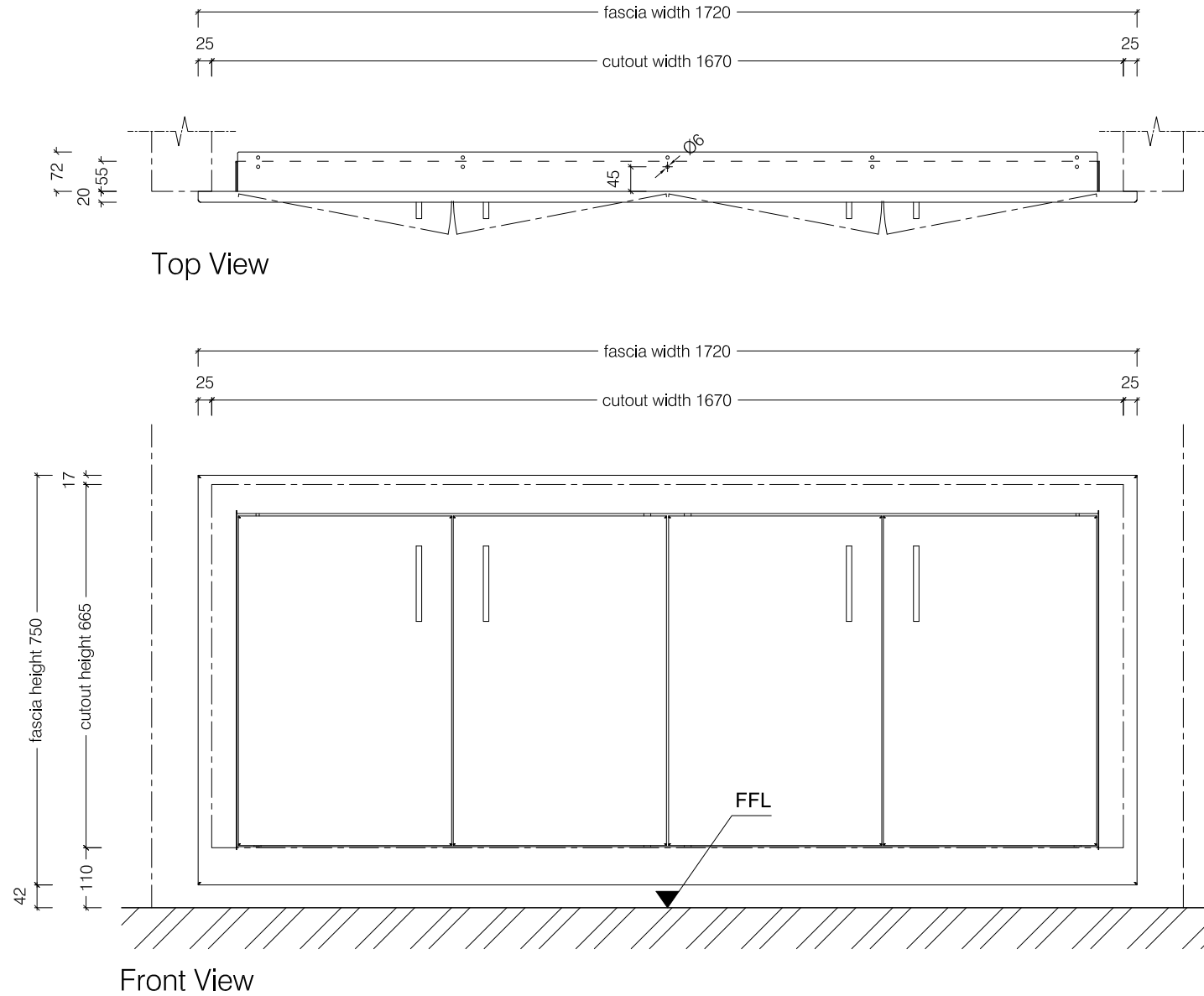

1600 Door Frame Set

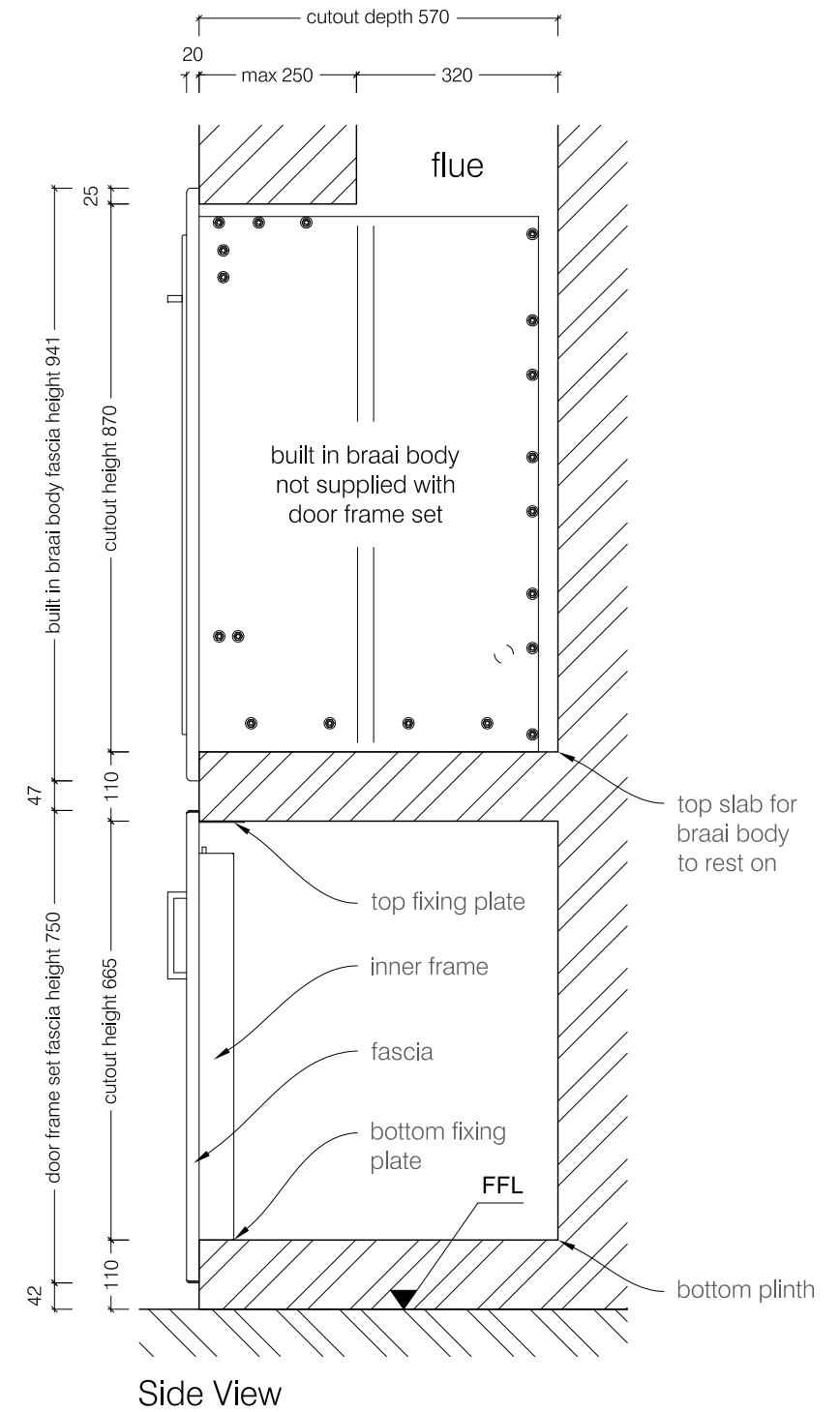
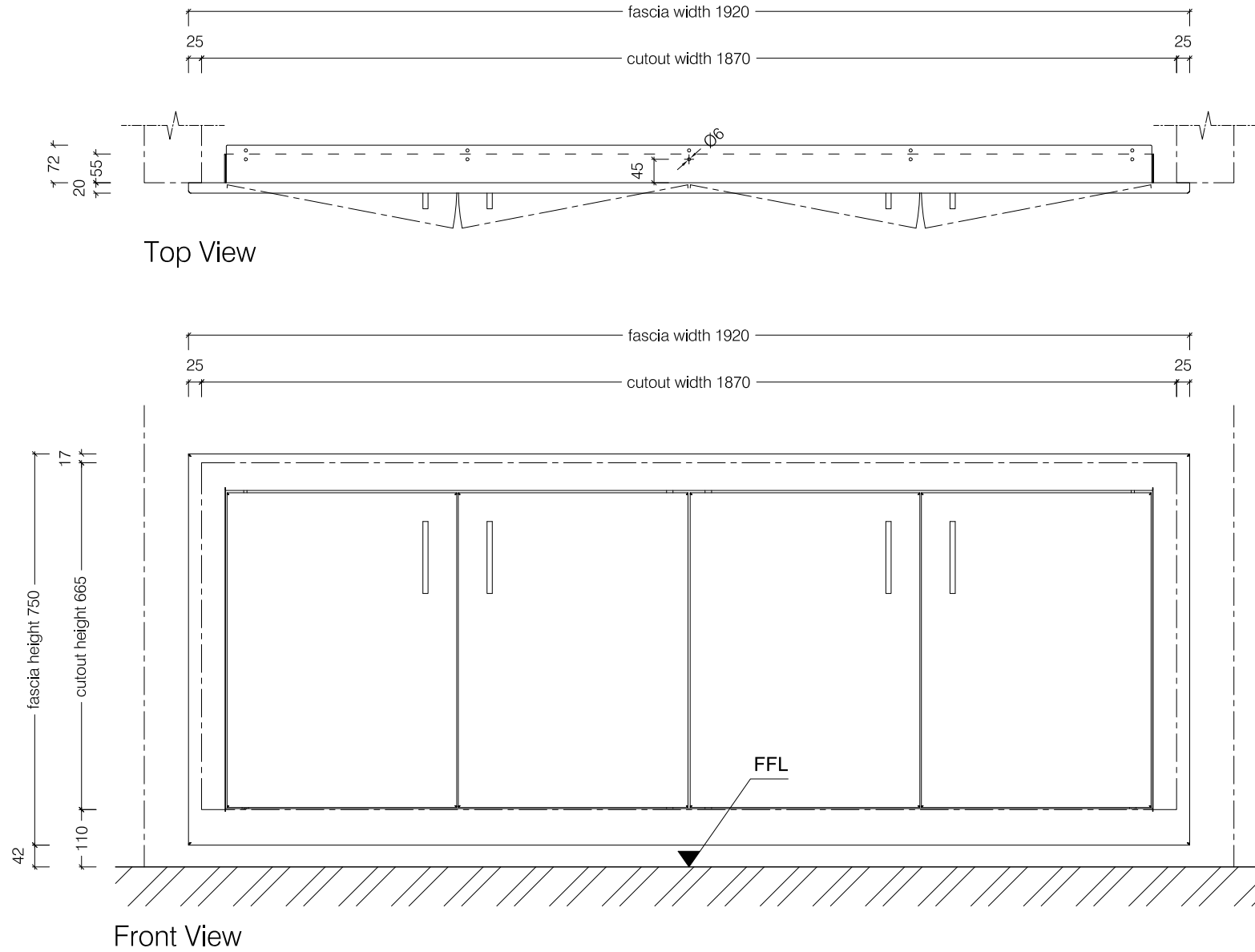

1800 Door Frame Set

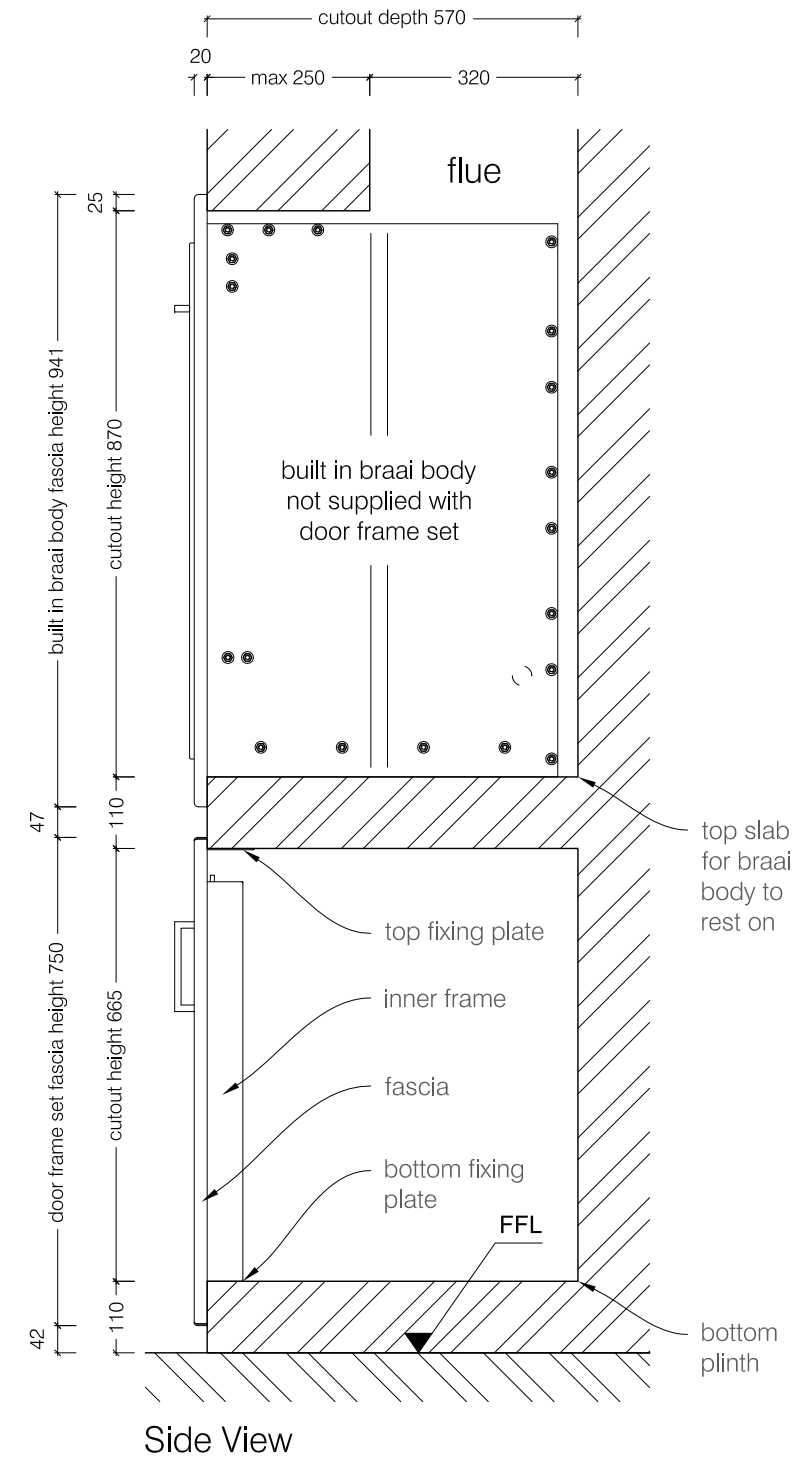
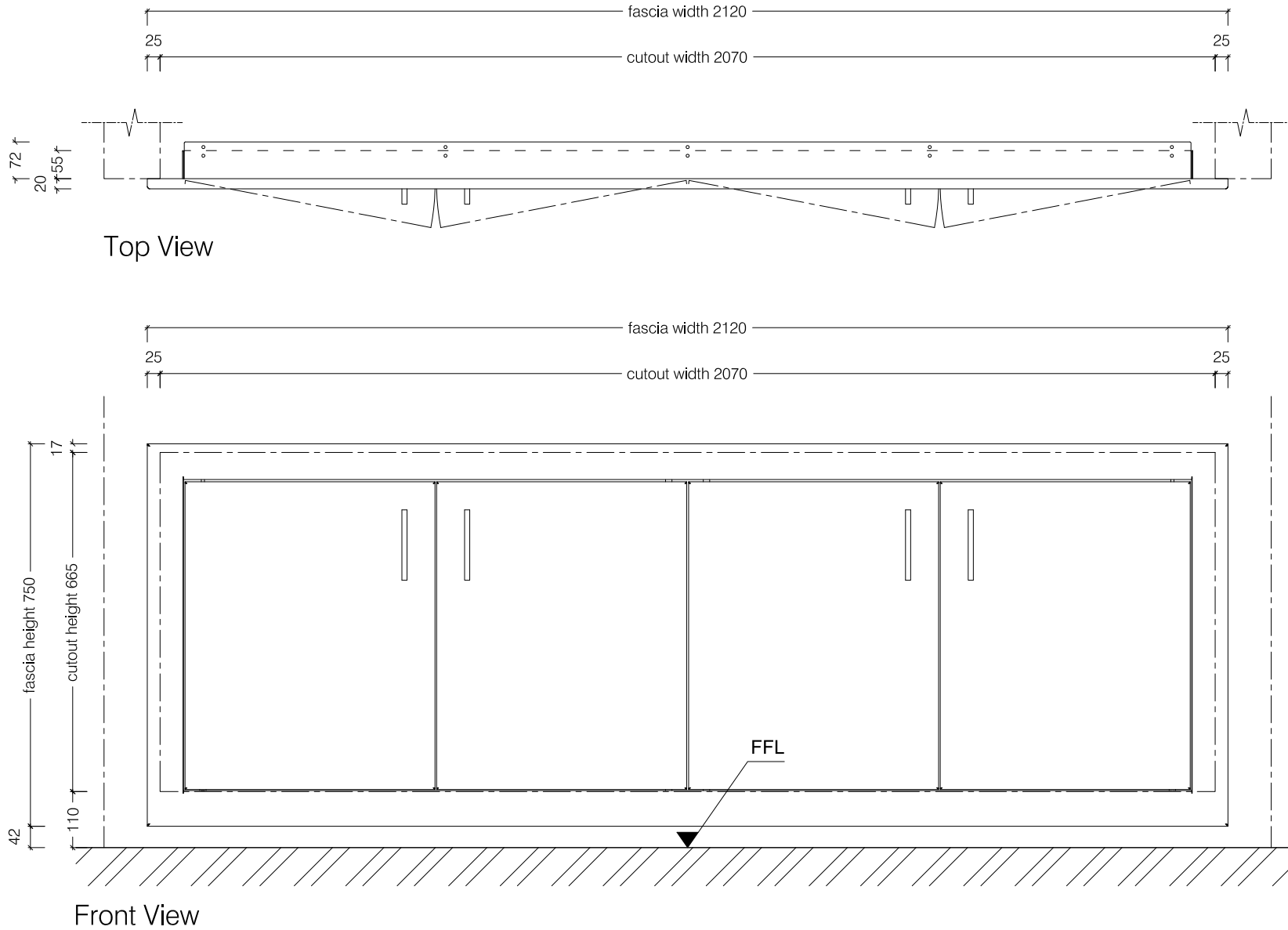

2000 Door Frame Set